

□42mm/□60mm/□85mm Hollow shaft type

Features

- Compact design and light weight with high accuracy, speed and torque
- Suitable for small-sized equipment applications
- Remove the coupling connecting Ball-screw, TM-screw directly.
- Remove resonance (vibration · noise) without coupling.
- Cost-effective

⚠ Please read "Caution for your safety" in operation manual before using.



42 Square

60 Square

85 Square

Dimensions

42 Square

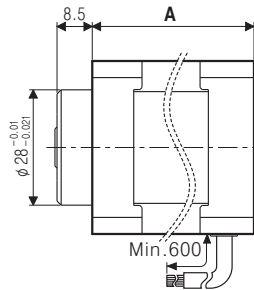
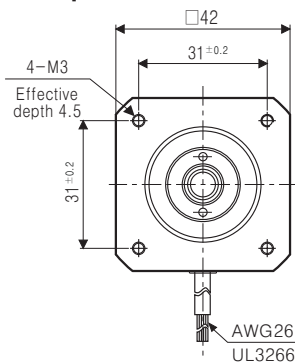

Hole Dimensions

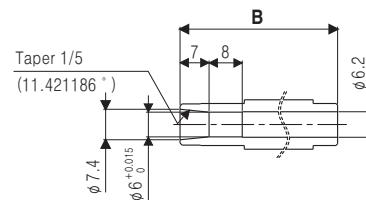

MODEL	A	B
AH1K-S543	33	38
AH2K-S544	39	44
AH3K-S545	47	52

(Unit:mm)

60 Square

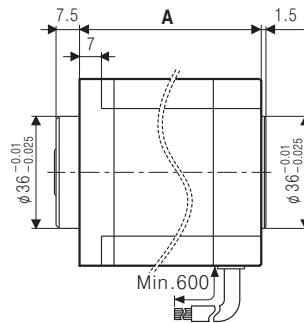
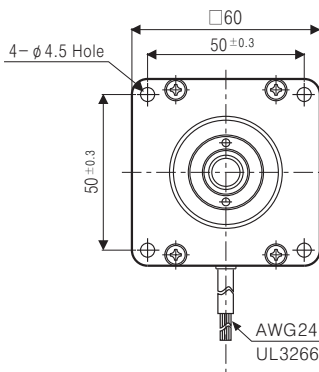

Hole Dimensions

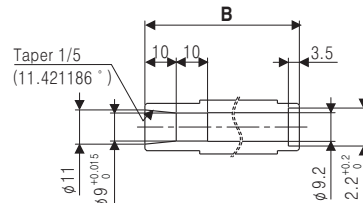

MODEL	A	B
AH4K-□564	48.5	49.3
AH8K-□566	59.5	60.3
AH16K-□569	89	89.8

(Unit:mm)

85 Square

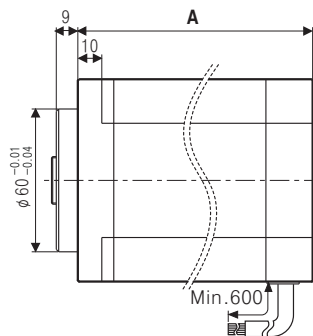
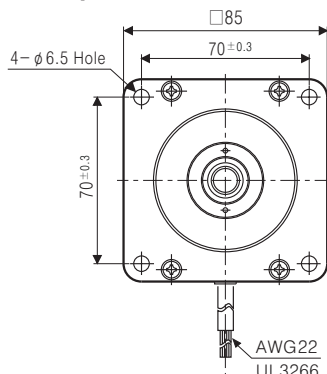

Hole Dimensions

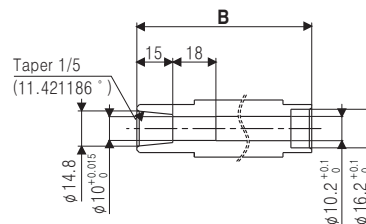

MODEL	A	B
AH21K-□596	68	73
AH41K-□599	98	102.5
AH63K-□5913	128	133

(Unit:mm)

* Depending on processing of shaft to be assembled, hollow shaft type can be used both single and dual shaft.

- (A) Photo electric sensor
- (B) Fiber optic sensor
- (C) Door/Area sensor
- (D) Proximity sensor
- (E) Pressure sensor
- (F) Rotary encoder
- (G) Connector/Socket
- (H) Temp. controller
- (I) SSR/Power controller
- (J) Counter
- (K) Timer
- (L) Panel meter
- (M) Tacho/Speed/Pulse meter
- (N) Display unit
- (O) Sensor controller
- (P) Switching power supply
- (Q) Stepping motor & Driver & Controller
- (R) Graphic/Logic panel
- (S) Field network device
- (T) Production stoppage models & replacement

AHK Series

Characteristic

●AH1K-S543

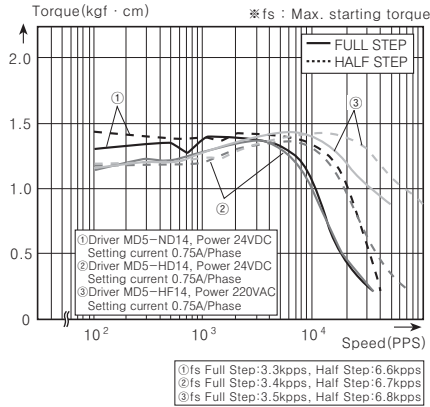

●AH2K-S544

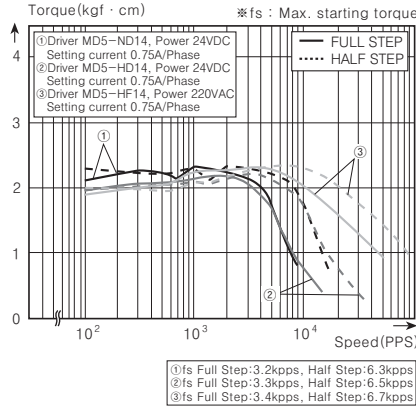

●AH3K-S545

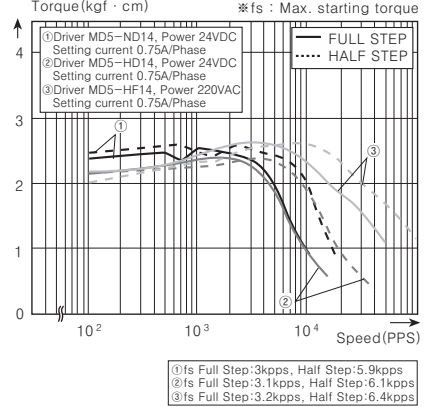

●AH4K-M564

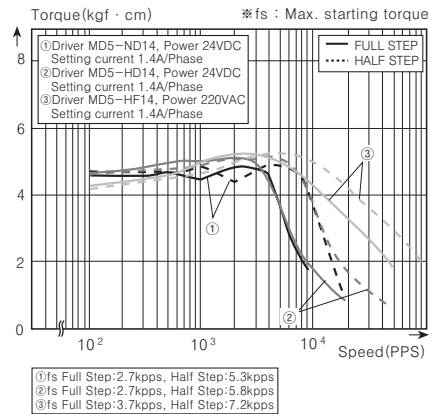

●AH8K-M566

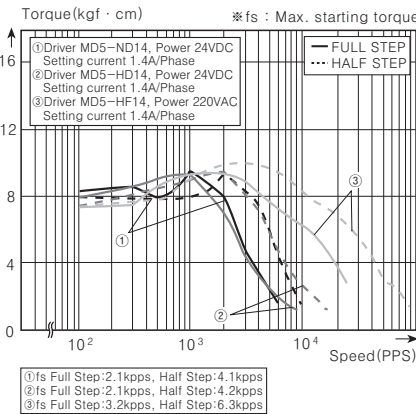

●AH16K-M(G)569

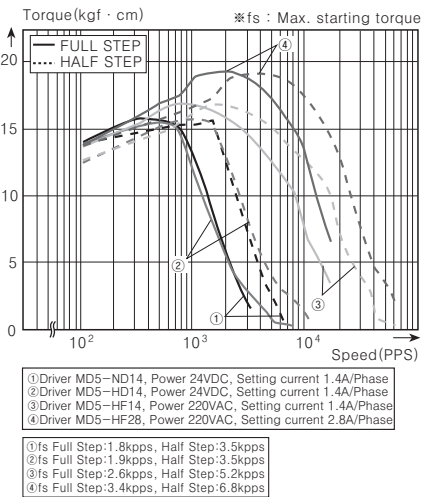

●AH21K-M(G)596

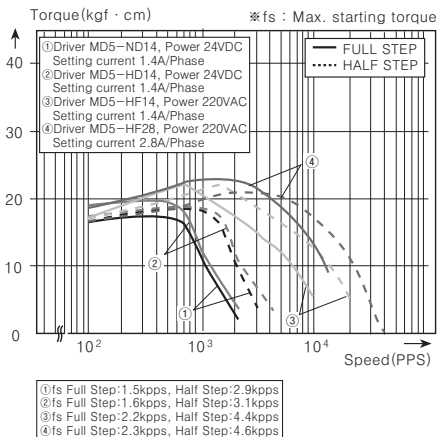

●AH41K-M(G)599

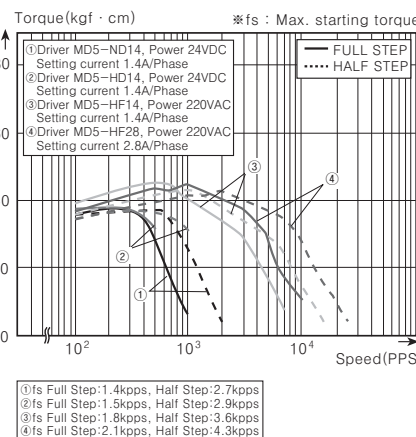

●AH63K-G5913

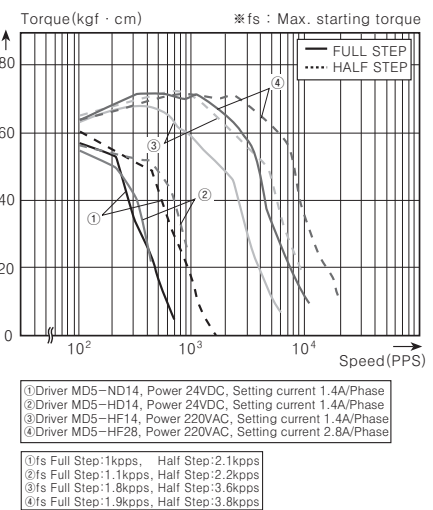

5-Phase Stepping Motor

■ Processing example for shaft assembly

In order to assemble external shafts into Autonics motors, the shafts must be processed as shown in the figures below.

●42 Square single shaft type

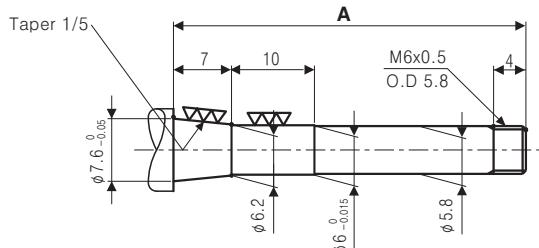

(Unit:mm)

MODEL	A
AH1K-S543	42.5
AH2K-S544	48.5
AH3K-S545	56.5

※ Lock Nut is included.

●42 Square dual shaft type

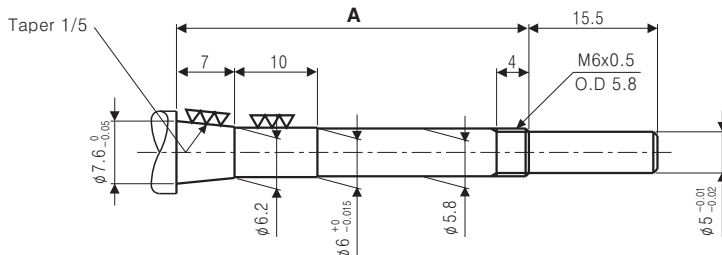

(Unit:mm)

MODEL	A
AH1K-S543W	42.5
AH2K-S544W	48.5
AH3K-S545W	56.5

※ Lock Nut is included.

●60 Square single shaft type

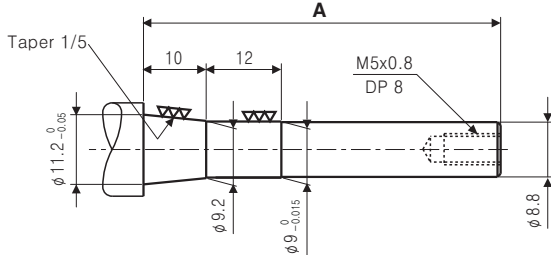

(Unit:mm)

MODEL	A
AH4K-□564	46
AH8K-□566	57
AH16K-□569	86.5

※ Hexagon wrench bolt, Flat washer, Spring washer and Lock Nut are included.

●60 Square dual shaft type

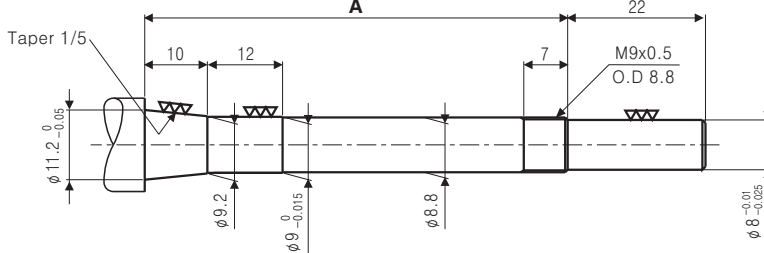

(Unit:mm)

MODEL	A
AH4K-□564W	56.5
AH8K-□566W	67.5
AH16K-□569W	97

※ Lock Nut is included.

●85 Square single shaft type

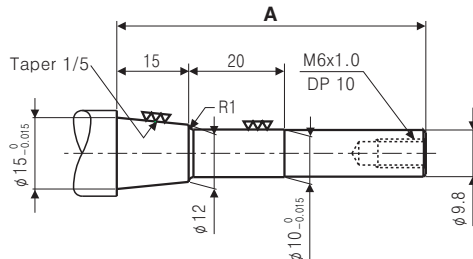

(Unit:mm)

MODEL	A
AH21K-□596	64.5
AH41K-□599	94
AH63K-□5913	124.5

※ Hexagon wrench bolt, Flat washer, Spring washer and Lock Nut are included.

●85 Square dual shaft type

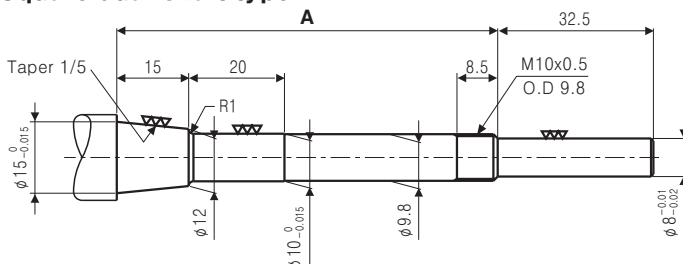

(Unit:mm)

MODEL	A
AH21K-□596W	79.5
AH41K-□599W	109.5
AH63K-□5913W	139.5

※ Lock Nut is included.

(A) Photo electric sensor

(B) Fiber optic sensor

(C) Door/Area sensor

(D) Proximity sensor

(E) Pressure sensor

(F) Rotary encoder

(G) Connector/Socket

(H) Temp. controller

(I) SSR/Power controller

(J) Counter

(K) Timer

(L) Panel meter

(M) Tacho/Speed/Pulse meter

(N) Display unit

(O) Sensor controller

(P) Switching power supply

(Q) Stepping motor & Driver & Controller

(R) Graphic/Logic panel

(S) Field network device

(T) Production stoppage models & replacement