

Digital indicating type fiber optic amplifiers

NEW

Features

- Dual-display for light incident level and setting value(BF5R-D)
- Minute object sensing available with 1/10,000 high resolution
- Ability to sense high-speed(20,000 times per sec.) moving objects
- 4 settings for response speed
: Ultra fast mode(50 μ s), high speed mode(150 μ s), standard mode(500 μ s), long distance mode(4ms)
- Long lasting amplifier regardless of element's life degradation or temperature change
- Multiple sensitivity setting modes available
: auto tuning, 1 point(maximum sensitivity), 2 point, positioning teaching
- Up to 8 units ability to stack with mutual interference prevention function using side connector
- Auto channel setting function for multiple installations
- Slim design(W10×H30×L70mm)



⚠ Please read "Caution for your safety" in operation manual before using.



Specifications

Display type	Dual Display type	Single Display type
Model	BF5R-D1-N	BF5R-S1-N
Light source	Red LED(660nm, modulated)	
Power supply	12-24VDC \pm 10%	
Current consumption	Max. 50mA	
Control output	NPN open collector (Sink Current : Max. 100mA, Applied Voltage : Max. 24V, Residual voltage : Max. 1V)	
Protection circuit	Reverse polarity, Overcurrent, Surge	
Response time	Ultra Fast : 50 μ s, Fast : 150 μ s, STD : 500 μ s, Long : 4ms	Fast : 150 μ s, STD : 500 μ s, Long : 4ms
Display	<ul style="list-style-type: none"> ●Incident light level: Red, 4 Digit, 7Segment ●SV : Green, 4 Digit, 7Segment ●Main output indicator : Red LED 	<ul style="list-style-type: none"> ●Incident light level /SV : Red, 4 Digit, 7Segment ●Main output indicator : Red LED
Display function	Incident light level / SV display [4000/10000 resolution], Percentage display, Peak / Bottom value display, Normal / Reversed display	
Sensitivity setting	Auto tuning, 1 point teaching, 2 point teaching, Positioning teaching	Auto tuning
Mutual interference prevention	Max. 8 unit sets (Automatically set regardless of response time)	
Initializing	Initializing to factory mode	—
Energy saving	Normal / Energy saving 1 / Energy saving 2	—
Timer	OFF, OFF delay, ON delay, One shot	OFF, 10ms OFF delay timer, 40ms OFF delay timer
Ambient illumination	Incandescent lamp : Max. 3000lx, Sunlight : Max. 11000lx	
Ambient temperature	Operation : -10 to 50 $^{\circ}$ C, Storage : -20 to 50 $^{\circ}$ C (at non-freezing state)	
Ambient humidity	35 to 85% RH	
Insulation resistance	Min. 20M Ω (at 500VDC megger)	
Dielectric strength	1000VAC 50/60Hz for 1 min.	
Vibration resistance	1.5 mm amplitude at frequency of 10 to 55Hz in each X, Y, Z direction for 2 hours	
Shock	500m/s ² (Approx. 50G) in X, Y, Z directions for 3 times	
Protection	IP40(IEC standard)	
Material	Case : PBT, Cover : PC	
Fiber cable Tightening torque	Min. 2kgf/cm ²	
Accessory	Connector type wire (ϕ 4, 3P, 2m), Side connector	
Approval	CE	
Unit weight	Approx. 20g	

- (A) Photo electric sensor
- (B) Fiber optic sensor
- (C) Door/Area sensor
- (D) Proximity sensor
- (E) Pressure sensor
- (F) Rotary encoder
- (G) Connector/Socket
- (H) Temp. controller
- (I) SSR/ Power controller
- (J) Counter
- (K) Timer
- (L) Panel meter
- (M) Tacho/ Speed/ Pulse meter
- (N) Display unit
- (O) Sensor controller
- (P) Switching power supply
- (Q) Stepping motor & Driver & Controller
- (R) Graphic/ Logic panel
- (S) Field network device
- (T) Production stoppage models & replacement

BF5 Series

Control output diagram and terminal connections

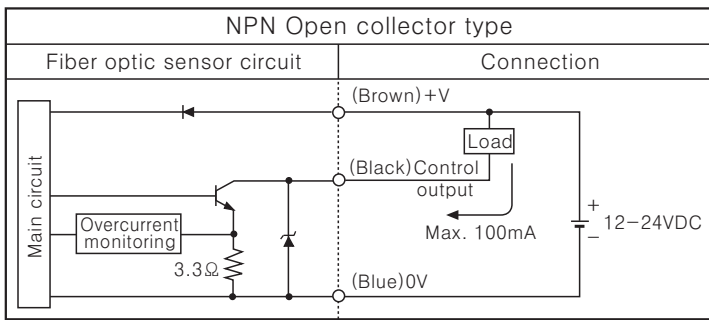

※Connect Diode at external terminal for inductive load.

Dimensions

(Unit:mm)

BF5R-D1-N



BF5R-S1-N

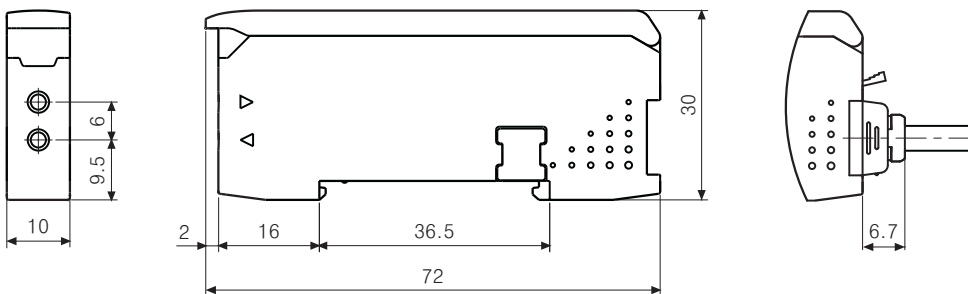
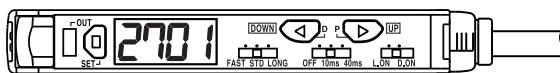

Accessories

- Connector type wire

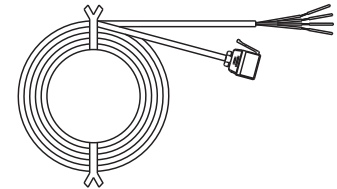

- Side connector

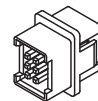

Installations

Amplifier unit mounting

- Attachment : Hang up the backside holder on DIN rail and press the unit toward the DIN rail.
- Detachment: Slide the back part and lift up the unit as shown in the figure ① and ②.

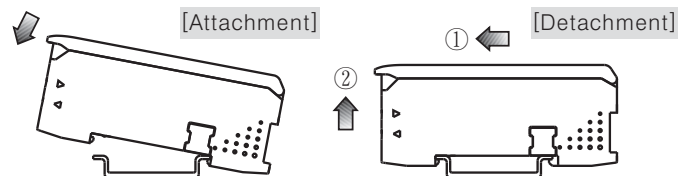

Amplifier unit connection

- After mounting one amplifier unit on DIN rail, remove the side cover and insert unit connector as shown in the figure ① and ②.
- Connect another unit through the connector as shown in the figure ③.
- ※Make sure that connections between unit case and connectors have made correctly. Improper connection may cause malfunctioning of channel setting and mutual interference prevention functions.
- ※Do not supply the power while connecting or disconnecting amplifier units.

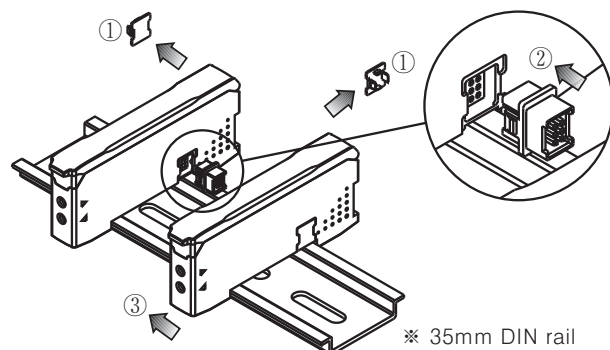

Fiber Optic Amplifier

◎Fiber cable connection

- Lift up the protective cover ① and push down the lock lever to the direction of ② to release the lock setting for fiber optic cable insertion.
- Insert the cable to the direction of ③ with slightly moving up and down 15°, and gently press into the unit until the cable is completely inserted.
- Lift up the lock lever to lock the lock setting ④ and close the protective cover ⑤.

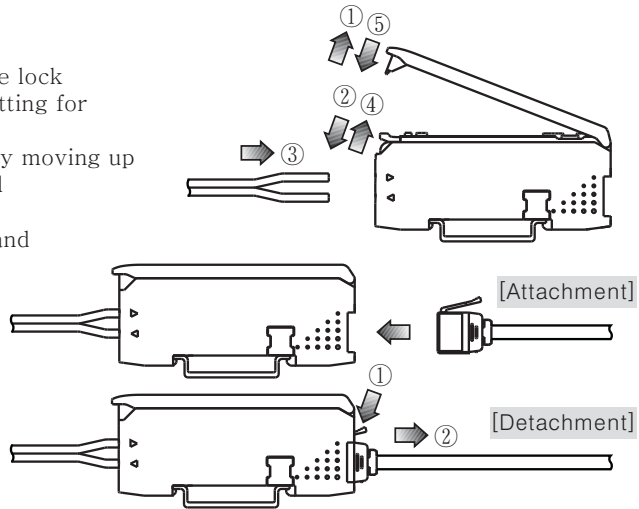

◎Wire connector connection

- Insert the connector into the amplifier unit until it clicks into right position.
- When removing the connector, pull out the connector pressing the lever down.

■Front part identification

◎BF5R-D1-N



- Control output indicator (Red)
: Used to indicate control output provided by comparing SV and actual incident light level.
- Sensitivity setting key
: Used to execute each operation and to set sensing sensitivity.
- PV display part (4 Digit, Red, 7 segments)
: Used to indicate incident light level and parameters.
- SV display part (4 Digit, Green, 7 segments)
: Used to indicate SV and setting data.
- Up/down key
●Used to up/down setting values
●Used to Fine-adjusting sensitivity
- MODE key
●Used to enter into program mode / data bank mode.
●Used to move each parameter.

◎BF5R-S1-N

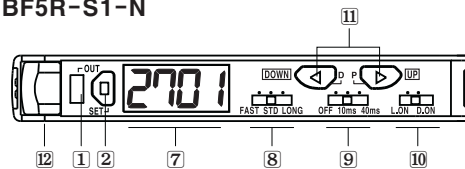

- PV/SV display part (4 Digit, Red, 7 segments)
: Used to indicate incident light level / SV and parameters
- Response time setting switch
: FAST, STD, LONG
- Timer setting switch
: Used to select OFF Delay time. (OFF, 10ms, 40ms)
- Operation mode setting switch
: Used to select Light ON / Dark ON.
- Up/Down key
●Used to up/down setting values
●Used to enter into each mode
●Used to Fine-adjusting sensitivity
- Lock lever

■Parameter setting

◎BF5R-D1-N

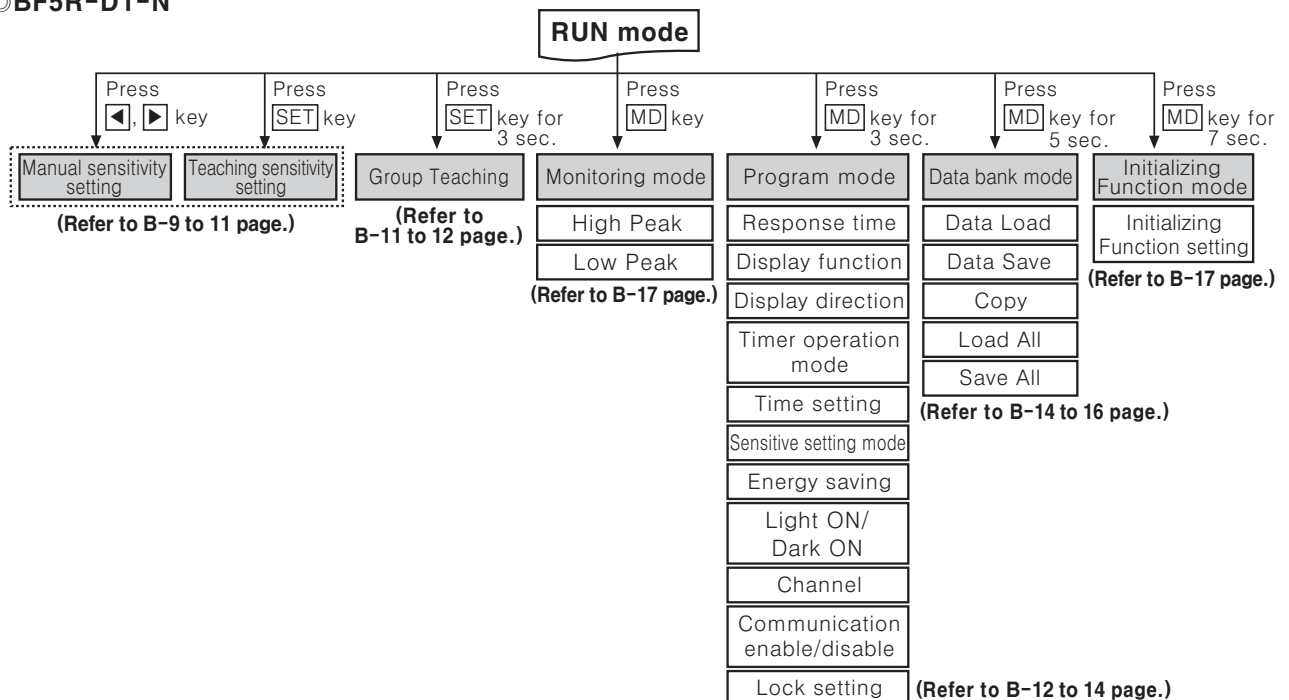

- (A) Photo electric sensor
- (B) Fiber optic sensor
- (C) Door/Area sensor
- (D) Proximity sensor
- (E) Pressure sensor
- (F) Rotary encoder
- (G) Connector/Socket
- (H) Temp. controller
- (I) SSR/Power controller
- (J) Counter
- (K) Timer
- (L) Panel meter
- (M) Tacho/Speed/Pulse meter
- (N) Display unit
- (O) Sensor controller
- (P) Switching power supply
- (Q) Stepping motor & Driver & Controller
- (R) Graphic/Logic panel
- (S) Field network device
- (T) Production stoppage models & replacement

BF5 Series

◎BF5R-S1-N

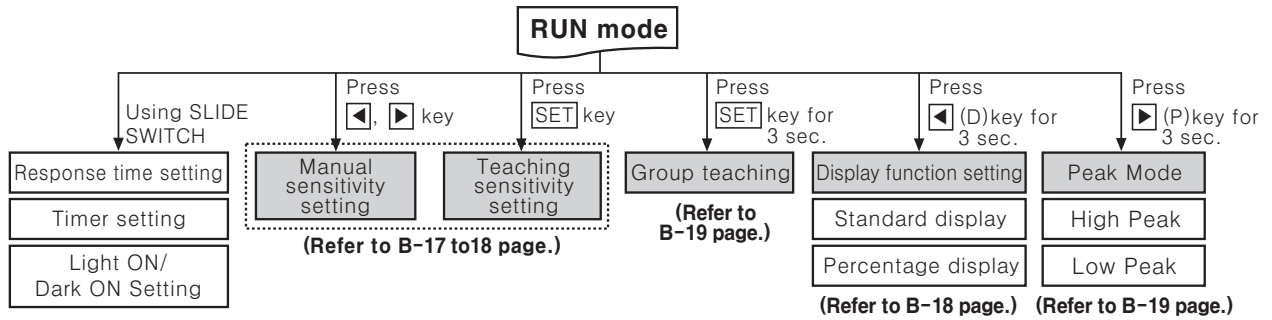

Dual display type (*Refer to B-9 to 17 page.)

■Sensitivity setting mode

※There are two methods available for sensitivity setting – manual or teach mode. Select the method most suitable for your application.

◎Manual sensitivity setting (Fine-adjusting sensitivity)

- The setting value can be directly changed by pressing the manual button
- Used to fine-adjusting sensitivity after teaching.
- Incident light level is still displayed on PV display part during setting.

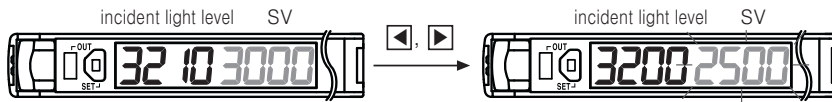

- ① Press and key to set the value.
- ② If there is no additional key input for 3 sec after completing setting, last set value will be flashing twice and automatically returned to RUN mode.

◎Teach sensitivity setting (Auto-tuning, One-point, Two-point, Positioning)

- How to enter into sensitivity setting mode in RUN mode
Press key once. Then, selected teaching mode parameter indicated by flashing twice on SV display part.
※Refer to [B-9 to 11] page for each teaching sensitivity setting.
- Teaching should be executed for over 3 sec.
※If teach mode is executed for less than 3 sec., teach mode parameter will flicker twice and be on standby to execute completion of teach mode.
- Current incident light level is indicated on PV display part while teaching is in the process.
- If incident light level is received under 10 DIGIT while teaching is in the process, it will be automatically returned to RUN mode and previous setting value will be retained after [ErrL] flashes twice.
※If there is no key operation for 60 sec. after entering into teaching mode, it will be automatically return to RUN mode.

1)Auto-tune teach mode

※Suitable when incident level of sensing object is not stable or when sensing fast moving objects.
※Auto-tune automatically sets the sensitivity using the average value of the incident light level within a certain time period.

$$\text{Set_value} = \frac{P1+P2+\dots+Pn-1+Pn}{n}$$

- Set Teaching mode parameter [SEn5] to "Aut α ".

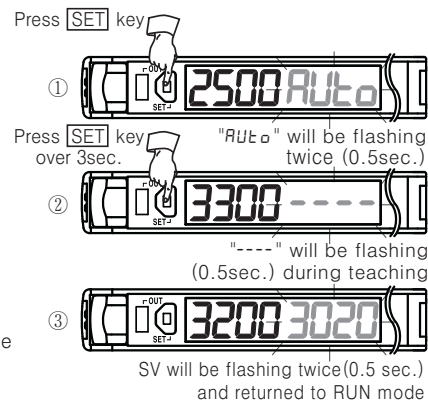
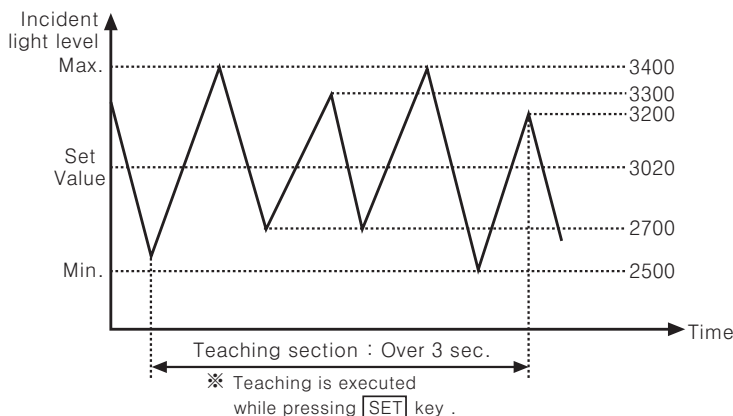

2) One-point teach mode

※One of teaching modes that sets the maximum sensitivity by teaching one sensitivity setting point when setting the SV with no sensing object (Reflective) or when setting the SV with incident light level 0 (Through-beam) / Suitable for the applications where dust or back ground will not effect sensing.

●Set Teaching mode parameter [5E_n5] to "IP_nt".

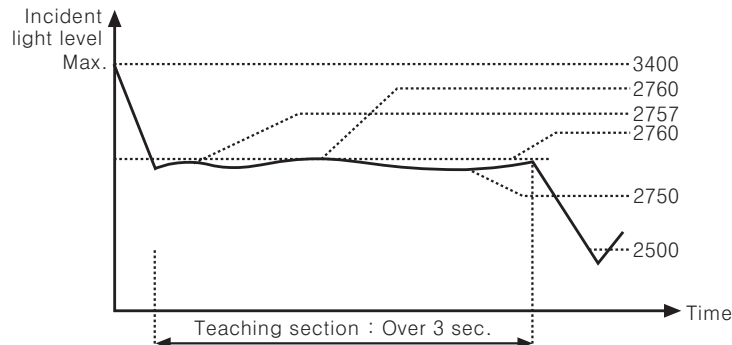

※ Teaching is executed while pressing [SET] key .

※SV range for sensing distance.

Response Time	Teaching when incident light level is 0	Teaching when incident light level is saturated
UF5t	In case incident light level is 0, set to 10 digit.	In case incident light level is saturated, set to 3980 digit.
F5t		
5td	In case incident light level is 0, set to 5 digit.	In case incident light level is saturated, set to 9980 digit.
L0G		

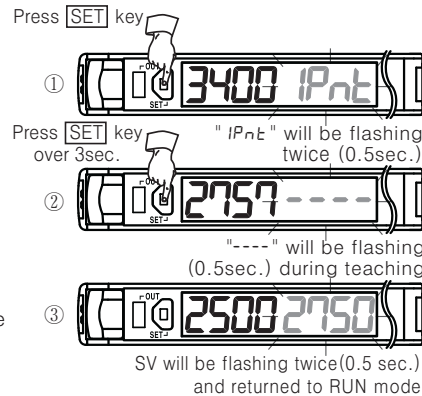

3) Two-point teach mode

※Suitable when incident light level is stable or when sensing object is slow or at stopped position.

※One of teaching modes that sets the sensitivity using average value of two incident light levels obtained from two point teaching – one point with a sensing object and the other point without a sensing object.

●Set teach mode parameter [5E_n5] to "2P_nt".

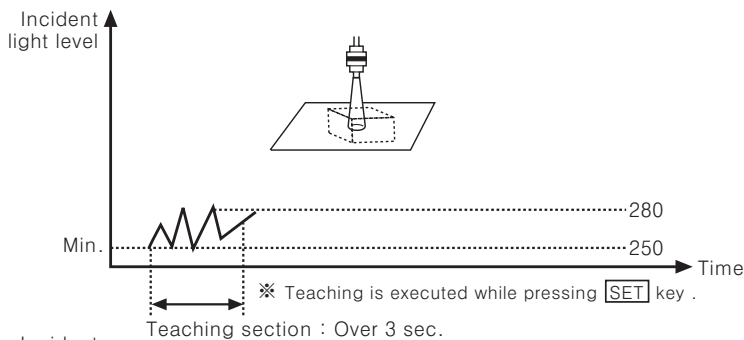

※ Teaching is executed while pressing [SET] key .

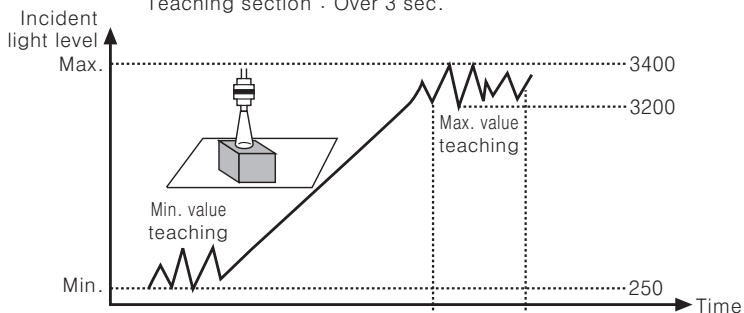

※ Teaching is executed while pressing [SET] key .

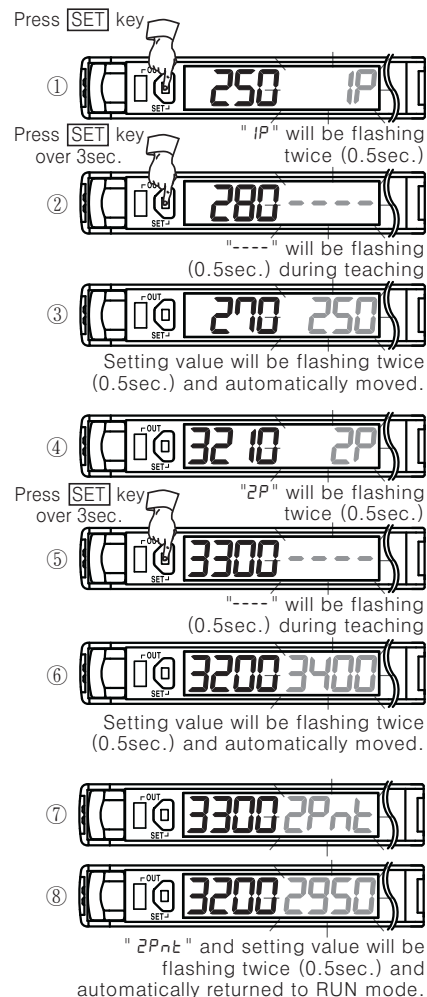
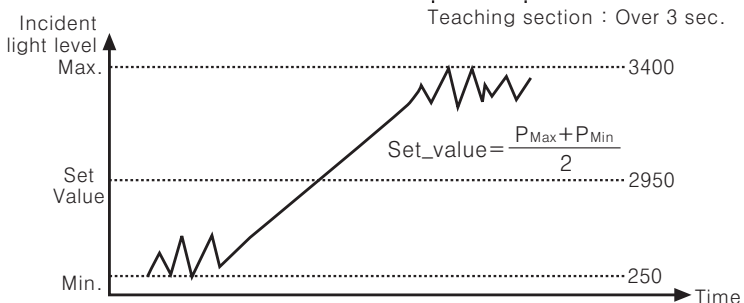

- (A) Photo electric sensor
- (B) Fiber optic sensor
- (C) Door/Area sensor
- (D) Proximity sensor
- (E) Pressure sensor
- (F) Rotary encoder
- (G) Connector/Socket
- (H) Temp. controller
- (I) SSR/Power controller
- (J) Counter
- (K) Timer
- (L) Panel meter
- (M) Tacho/Speed/Pulse meter
- (N) Display unit
- (O) Sensor controller
- (P) Switching power supply
- (Q) Stepping motor & Driver & Controller
- (R) Graphic/Logic panel
- (S) Field network device
- (T) Production stoppage models & replacement

BF5 Series

4) Positioning teach mode

※One of teaching modes that sets the sensitivity to 90% of max. incident light level when sensing an object with a hole on the surface (Through-beam) or sensing a moving object having curve (Reflective).

●Set teach mode parameter [5En5] to "P5En".

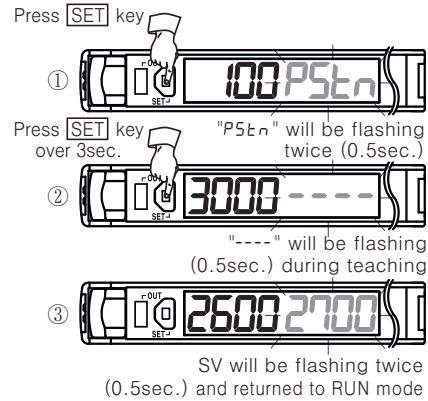
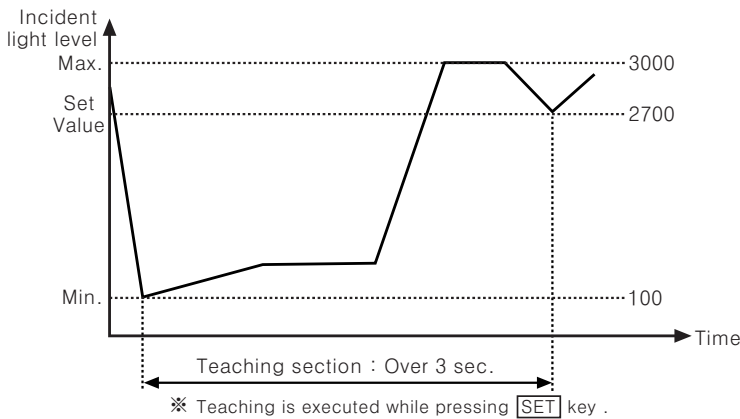

■ Ground teach mode

A function to set the sensitivity of slave amplifier units according to the command of master amplifier unit (certain amplifier unit) in a successive and collective way.

※In case of two-point teach mode, Group teaching is not applicable.

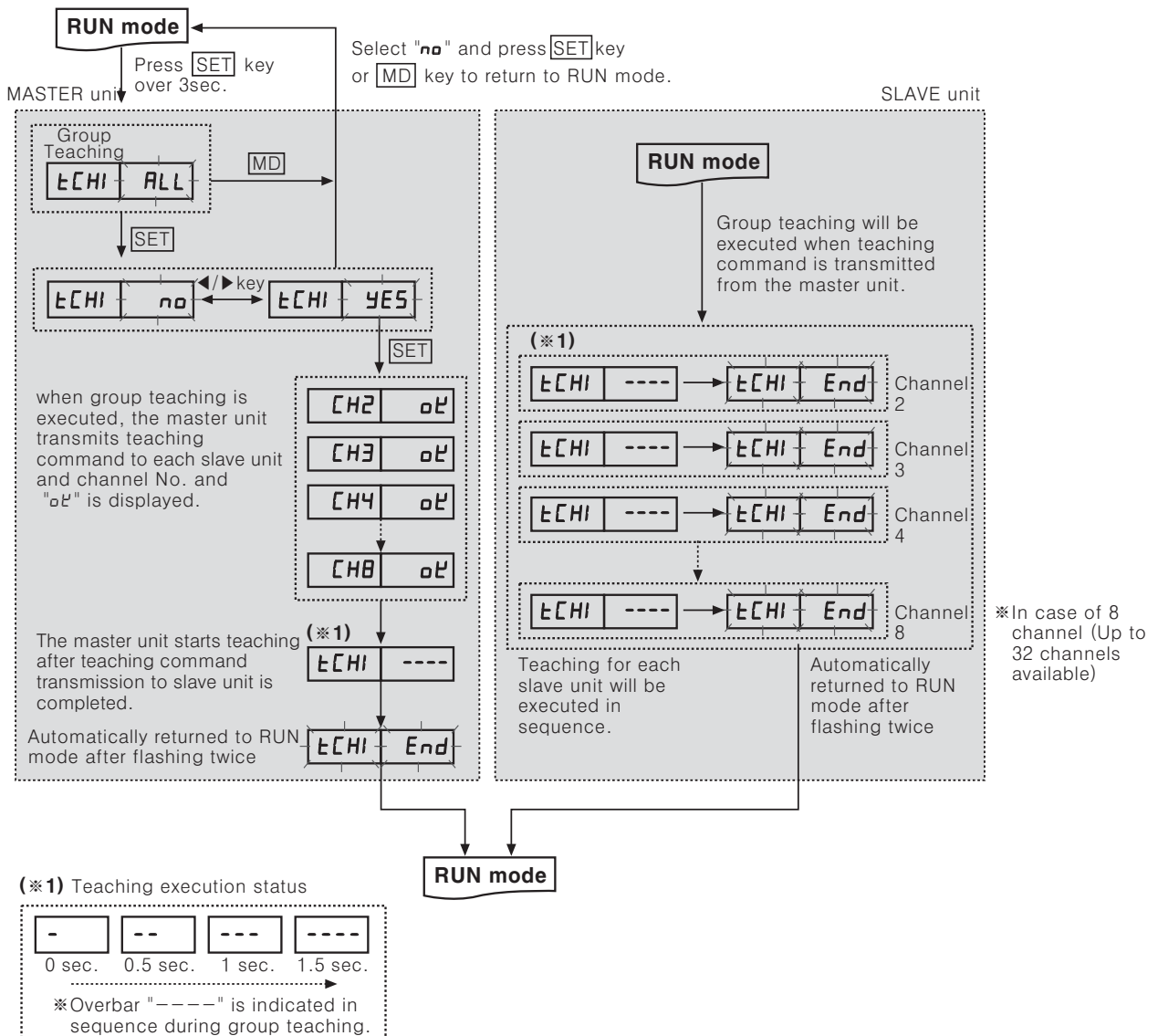

Fiber Optic Amplifier

● MASTER / SLAVE unit display during group teach mode

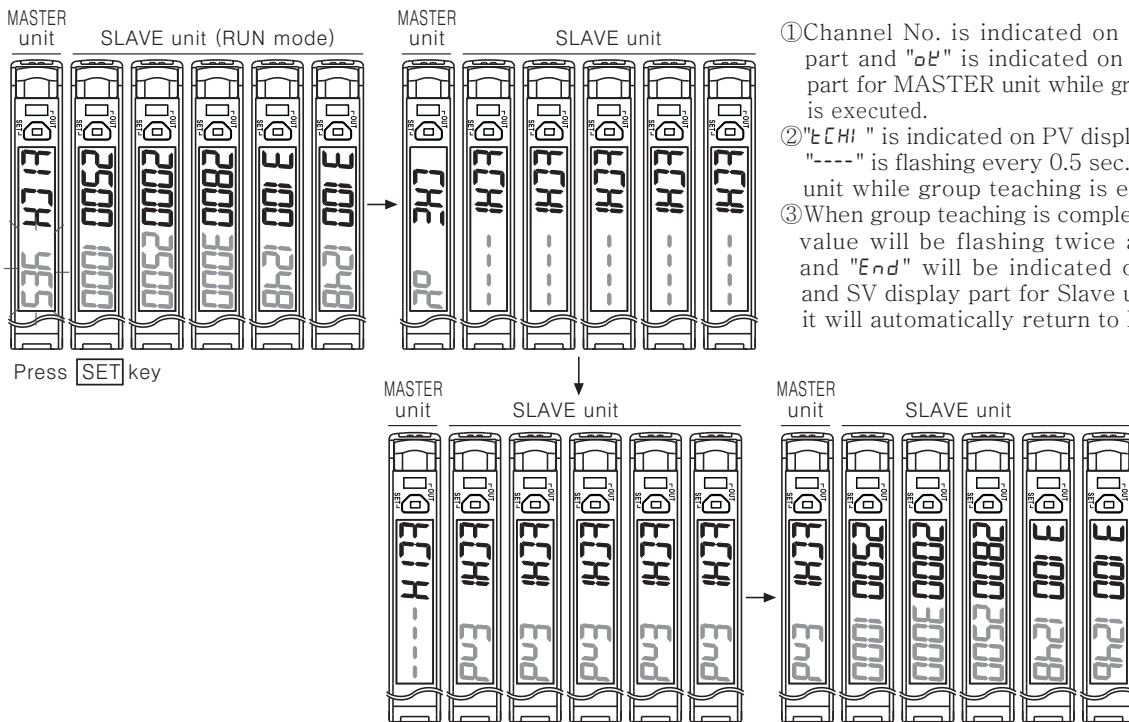

- ① Channel No. is indicated on PV display part and "oE" is indicated on SV display part for MASTER unit while group teaching is executed.
- ② "tCH" is indicated on PV display part and "----" is flashing every 0.5 sec. for SLAVE unit while group teaching is executed.
- ③ When group teaching is completed, setting value will be flashing twice and "tCH" and "End" will be indicated on both PV and SV display part for Slave units. Then, it will automatically return to RUN mode.

■ Program mode setting

- When entering into program mode, parameters will light ON on PV display part and setting values will be flashing every 0.5 sec. on SV display part. Use ◀, ▶ key to set each setting value.
- Press [MD] key one time after setting each parameter to save each setting and enter into next mode.
- If the key lock is set (lock1 or lock2), unlock the key lock before setting parameters.

● Program mode flow

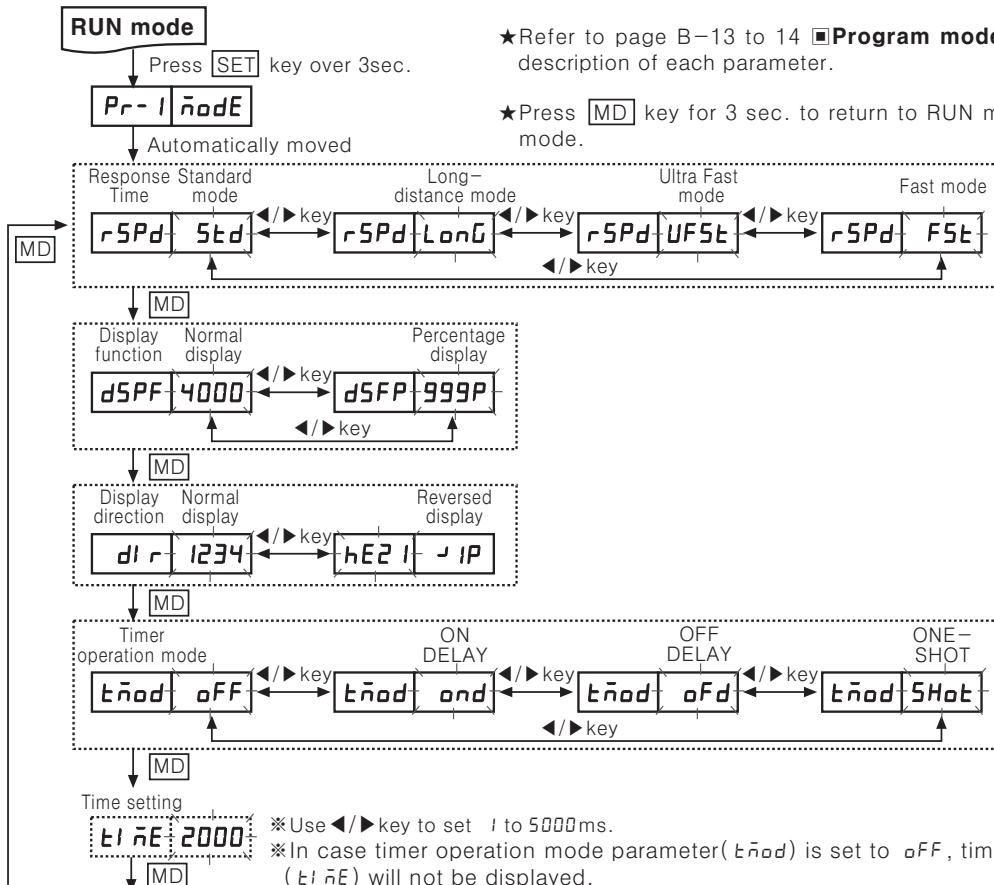

★ Refer to page B-13 to 14 **■ Program mode function** for further description of each parameter.

★ Press [MD] key for 3 sec. to return to RUN mode while in program mode.

※ Use ◀/▶ key to set 1 to 5000ms.

※ In case timer operation mode parameter (tnod) is set to oFF, time setting parameter (tNE) will not be displayed.

- (A) Photo electric sensor
- (B) Fiber optic sensor
- (C) Door/Area sensor
- (D) Proximity sensor
- (E) Pressure sensor
- (F) Rotary encoder
- (G) Connector/Socket
- (H) Temp. controller
- (I) SSR/Power controller
- (J) Counter
- (K) Timer
- (L) Panel meter
- (M) Tacho/Speed/Pulse meter
- (N) Display unit
- (O) Sensor controller
- (P) Switching power supply
- (Q) Stepping motor & Driver & Controller
- (R) Graphic/Logic panel
- (S) Field network device
- (T) Production stoppage models & replacement

BF5 Series

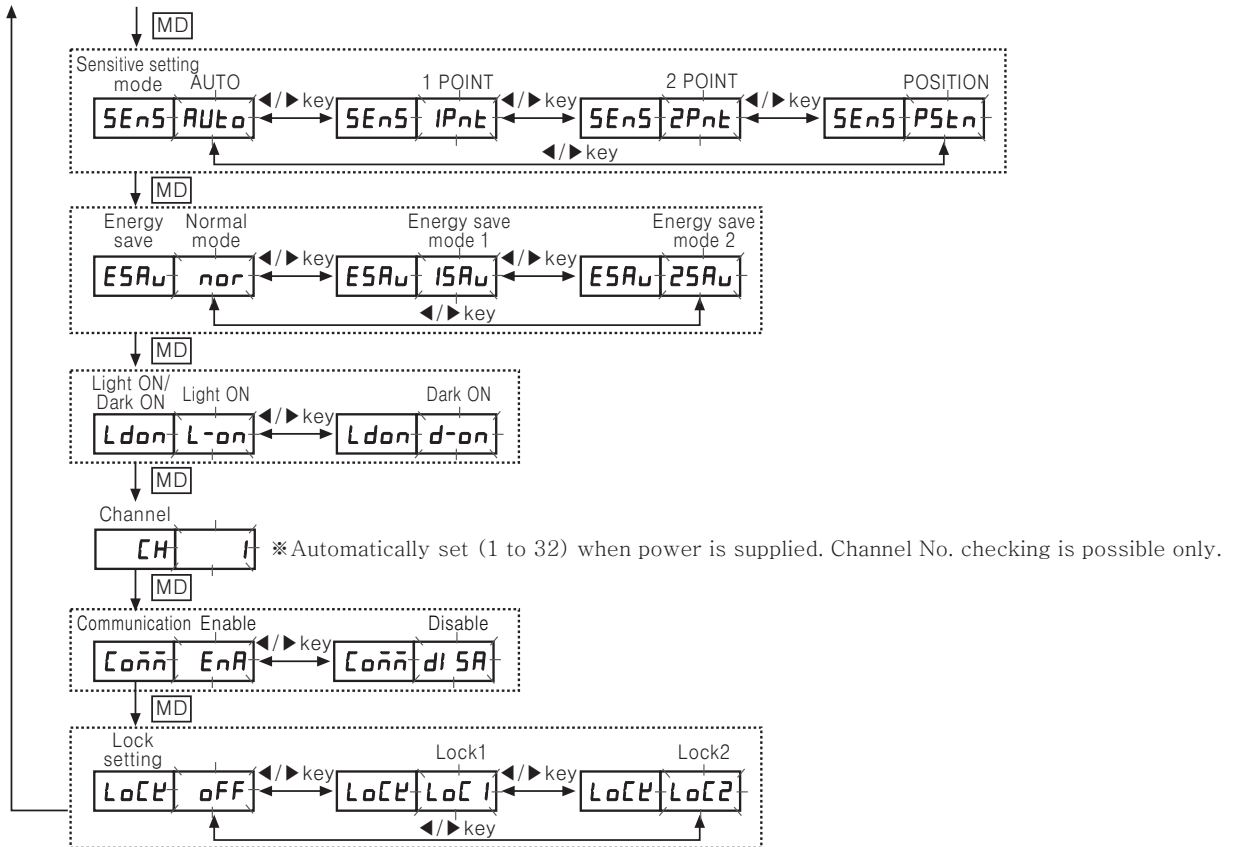

Program mode function

Response time setting [rSPd]

A function to set the response time of control output – 4 response modes selectable.

- Ultra Fast (UF5t) mode : 50μs
- Fast (F5t) mode : 150μs
- Standard (5td) mode : 500μs
- Long distance (LonU) mode : 4 ms

Display function [dSPF]

A function to select incident light level display mode on PV display window : Standard display (4000) / Percentage display (999P)

- Standard Mode Display Range : 0 to 4000 (0 to 9999, in case of long distance mode)
- Percentage Mode Display Range : 0P to 999P (No decimal point displayed)

Display direction setting function [dl r]

A function to reverse the display direction to suit the unit installation location. : Normal display / Reversed display selectable.
 ※ Reversed display is upside-down display of normal display.

Timer function [Timer operation mode : tnod, Time setting : tI nE]

Used when external device's response time is too late or when control output time is too short due to small sensing object – 3 modes available.

- Timer Off [oFF]
- On Delay [ond] : A mode in which control output ON time is delayed for a certain period of setting time.
- Off Delay [oFd] : A mode in which control output OFF time is delayed for a certain period of setting time.
- One Shot [SHot] : A mode in which control output becomes ON or OFF within a certain period of setting time.
- Time setting [tI nE] : 1 to 5000ms

Time chart

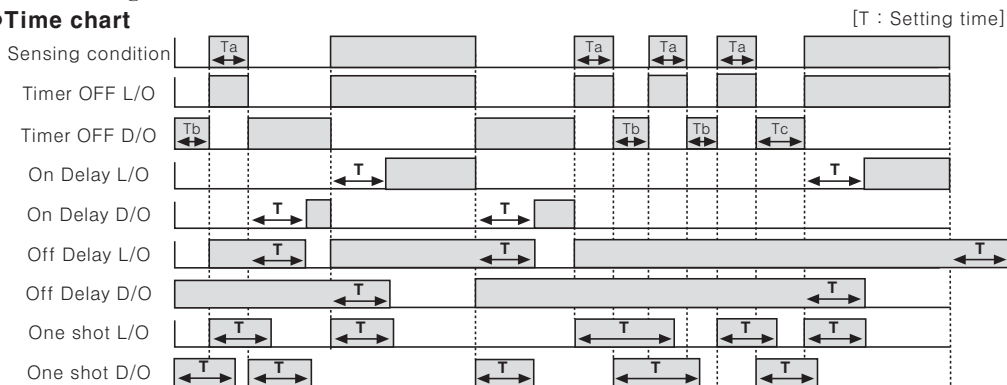

※ Setting time : $T > T_a$, $T > T_b$, $T > T_c > T_b$

Fiber Optic Amplifier

(A)	Photo electric sensor
(B)	Fiber optic sensor
(C)	Door/Area sensor
(D)	Proximity sensor
(E)	Pressure sensor
(F)	Rotary encoder
(G)	Connector/Socket
(H)	Temp. controller
(I)	SSR/Power controller
(J)	Counter
(K)	Timer
(L)	Panel meter
(M)	Tacho/Speed/Pulse meter
(N)	Display unit
(O)	Sensor controller
(P)	Switching power supply
(Q)	Stepping motor & Driver & Controller
(R)	Graphic/Logic panel
(S)	Field network device
(T)	Production stoppage models & replacement

◎Energy saving function [E5A]

A function to save unit's power consumption by reducing power supply to display parts in case of no setting input within 60 sec.

- Selectable from 2 power saving modes
 - ☞ Normal mode [n0r] : Main output indicator (OUT), PV/SV display part ON
 - ☞ Energy saving mode 1 [15A] : Main output indicator (OUT) and PV display part ON
 - ☞ Energy saving mode 2 [25A] : Main output indicator (OUT) ON

◎Light ON / Dark ON switching function [Ldon]

A function to set Light ON – control output is ON when incident light level is higher than setting value Dark ON – control output is ON when incident light level is lower than setting value.

◎Communication enable / disable setting function [C0nn]

A function to set Slave amplifier unit's communication [enable (E nA) / disable (d i 5A)] while certain instructions (LOAD/SAVE/COPY) or group teaching is in progress by Master amplifier units.

◎Lock function [L0L]

Two types of key lock setting available in order to prevent SV changes due to lack of care.

	oFF	L0L1	L0L2
Sensitivity setting	●	◐	◐
Data bank mode	●	○	○
Program mode	●	◐	○
Parameter Reset	●	○	○

- ※ ●:Check / Setting both available
- ◐:Check available
- :Check / Setting both unavailable

- In case of [L0L2] mode, it is required to disable the lock function first to enter into parameter mode.

■Data bank setting

A function to save settings for group amplifier units in each data bank by using master unit's command or by adjusting one amplifier unit's setting and to load required data bank when it is necessary without resetting for each unit's parameters and setting values.

- LOAD [L0Ad] : Load preset databank (bAEd, 1, 2) and apply it to the amplifier unit.
 - ☞ Detailed bank parameters can be read and changed.
- SAVE [5AUE] : Save one amplifier unit settings in one of databank (bAEd, 1, 2).
- COPY [C0PY] : Select one databank according to MASTER's instructions and copy it in another unit (1:1) or entire group units (1: M).
- LOAD ALL [L0AL] : Select one databank according to MASTER's instructions load it to entire group units.
- SAVE ALL [5uAL] : Select one databank according to MASTER's instructions and save it in entire group units.

※ Up to 3 databanks are available [bAEd, 1, 2] and each bank can be read and changed.

It allows users to detect three different sensing objects using one amplifier unit without resetting each parameter.

※ For BF5-D1-N, three data banks are available ([bAEd], [bAL1] and [bAL2]) so that three different sensing object information can be saved. Each bank can be read and changed. It allows users to detect three different sensing objects with one amplifier unit without resetting each parameter.

※ Databank function can be executed only if all amplifier units are in RUN mode.

※ COPY/LOAD ALL/SAVE ALL functions are applicable only if multiple amplifier units are connected.

※ If lock function is set (L0L1 / L0L2) on amplifier units or if the SLAVE unit is set to communication disable [d i 5A], LOAD and SAVE command for the unit will not be executed.

BF5 Series

•Data bank mode flow

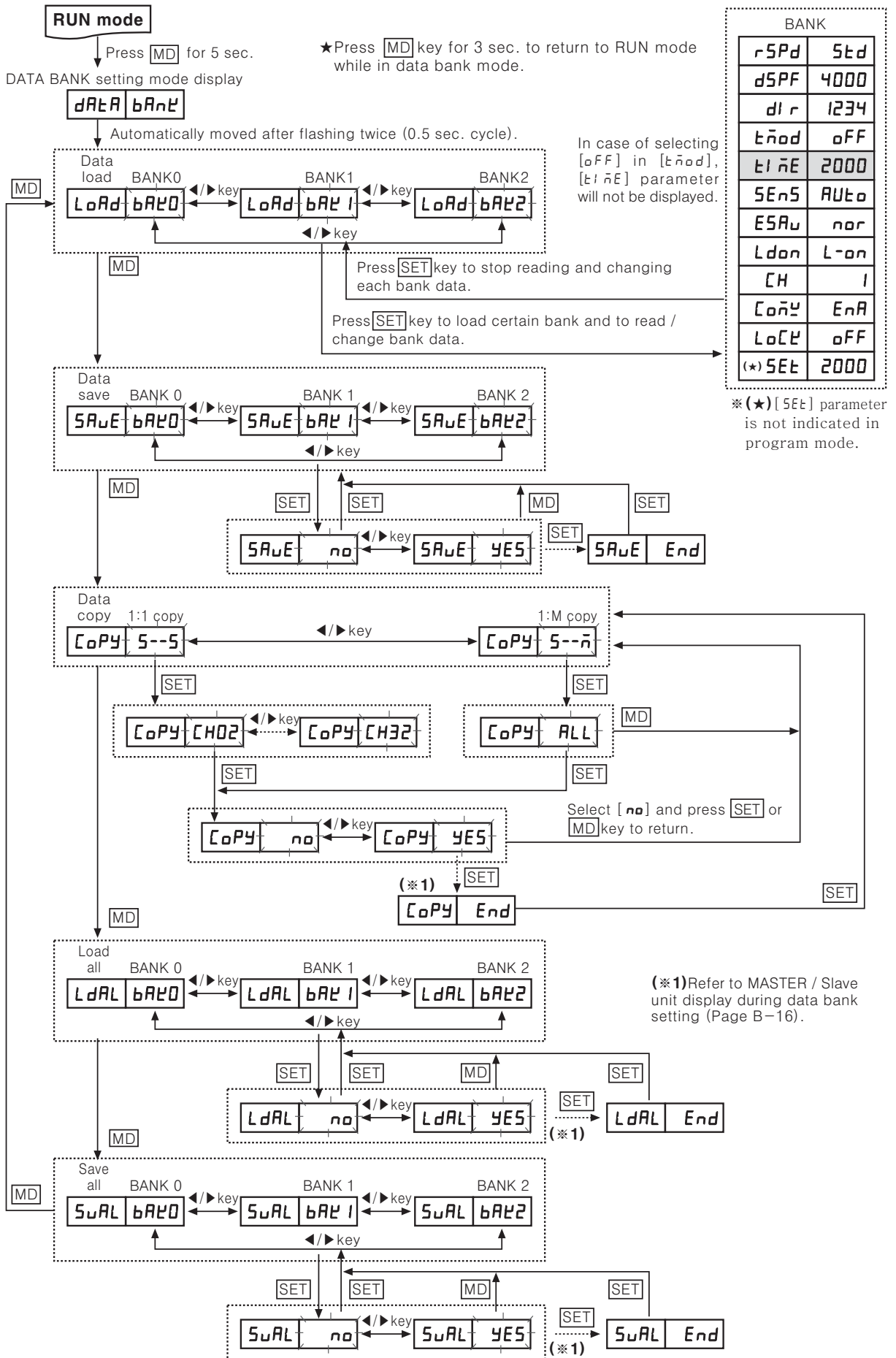

Fiber Optic Amplifier

● MASTER / SLAVE unit display during data bank setting

■ COPY ALL

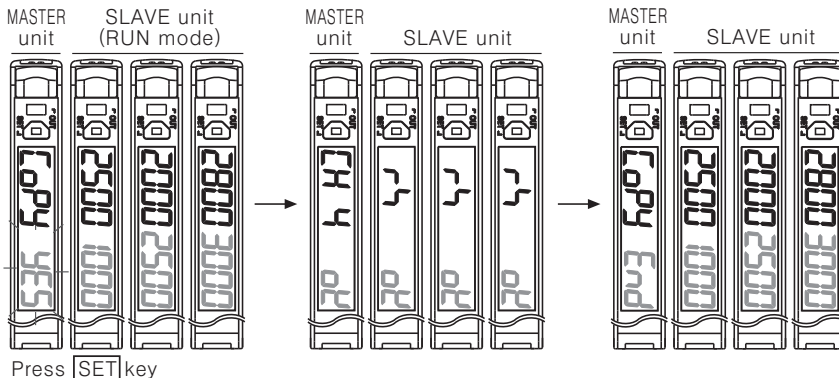

- ① Channel No. is indicated on PV display part and "00" is indicated on SV display part for master unit while COPY is executed.
- ② "4" is indicated on PV display part and "00" is indicated on SV display part for slave units while COPY is executed. Then, it is returned to RUN mode.
- ③ When Copy is completed, "Copy End" is indicated on PV display part and "End" is indicated on SV display part for master unit. Press **SET** key to return to data copy mode.

■ LOAD ALL

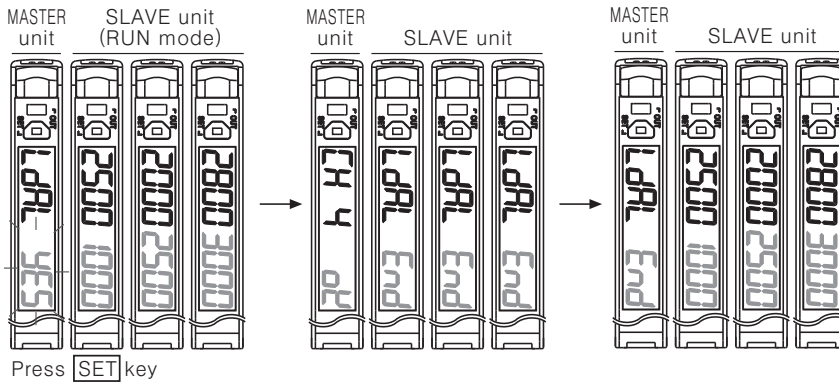

- ① Channel No. is indicated on PV display part and "00" is indicated on SV display part for master unit while LOAD ALL is executed.
- ② "LdRL" is indicated on PV display part and "End" is indicated on SV display part for slave units while LOAD ALL is executed. Then, it is returned to RUN mode.
- ③ When LOAD ALL is completed, "LdRL" is indicated on PV display part and "End" is indicated on SV display part for master unit. Press **SET** key to return to Load All mode.

■ SAVE ALL

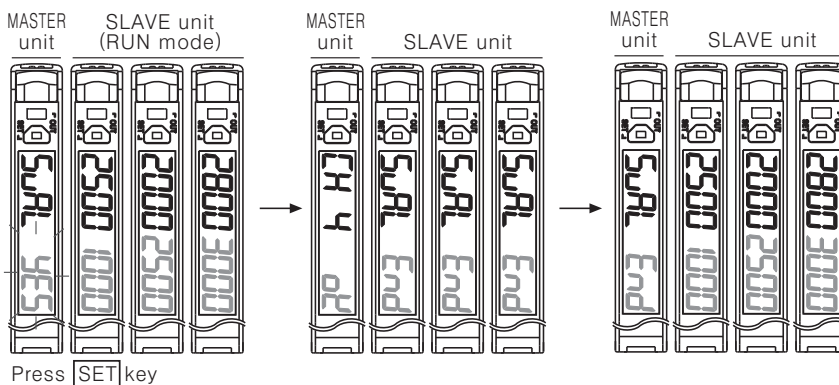

- ① Channel No. is indicated on PV display part and "00" is indicated on SV display part for master unit while SAVE ALL is executed.
- ② "SuRL" is indicated on PV display part and "End" is indicated on SV display part for slave units while SAVE ALL is executed. Then, it is returned to RUN mode.
- ③ When SAVE ALL is completed, "SuRL" is indicated on PV display part and "End" is indicated on SV display part for master unit. Press **SET** key to return to Save All mode.

※ If communication enable / disable parameter [C000] for SLAVE unit is set to communication disable while SAVE ALL, LOAD ALL or COPY is executed, Master unit displays Channel No. on PV display part and [d1 5R] on SV display part.

(A)	Photo electric sensor
(B)	Fiber optic sensor
(C)	Door/Area sensor
(D)	Proximity sensor
(E)	Pressure sensor
(F)	Rotary encoder
(G)	Connector/Socket
(H)	Temp. controller
(I)	SSR/Power controller
(J)	Counter
(K)	Timer
(L)	Panel meter
(M)	Tacho/Speed/Pulse meter
(N)	Display unit
(O)	Sensor controller
(P)	Switching power supply
(Q)	Stepping motor & Driver & Controller
(R)	Graphic/Logic panel
(S)	Field network device
(T)	Production stoppage models & replacement

BF5 Series

High peak, Low peak function

A function to monitor high/low peak value of incident light level. Monitored high/low peak value can be initialized.

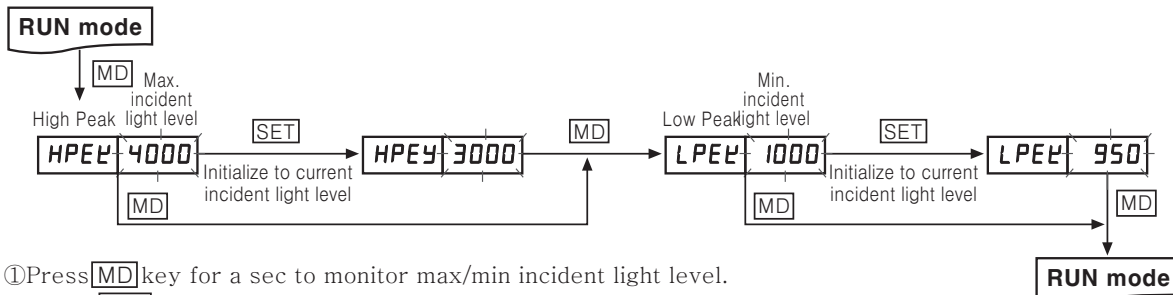

- ① Press **[MD]** key for a sec to monitor max/min incident light level.
- ② Press **[SET]** key to initialize max/min value to current incident light level during monitoring.
- ③ Press **[MD]** key to return to RUN mode.

Initializing function

A function to initialize all parameters in memory to default value in case the possibility of missetting or misoperation.

- ※ Set lock function [**L o C k**] to **[o F F]** to execute Initializing Function.
- ※ High peak value [**H P E L**] and low peak value [**L P E L**] shall not be initialized.

Parameter initialize flow

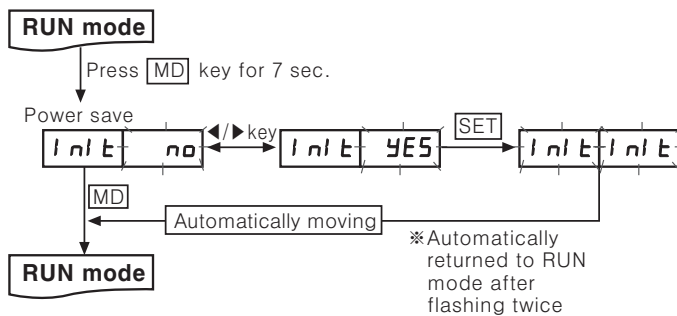

- ① Press **[MD]** key for 7 sec. in RUN mode. "I n i t" parameter will light ON on PV display part and "no" will be flashing every 0.5sec. on SV display part.
- ② Press **[MD]** key once again to return to RUN mode without executing initializing Function.
- ③ Select "YES" using **[◀, ▶]** key and press **[SET]** key. "I n i t" will be flashing twice on both PV and SV display part.
- ④ When initializing Function is completed, it is automatically returned to RUN mode.

Initializing function parameter value (Factory mode)

Parameter	Initializing value	Parameter	Initializing value	Parameter	Initializing value
rSPd	5td	tñod	oFF	Ldon	L-on
dSPF	4000	SEnS	RUto	Coññ	EnR
dlr	1234	ESRu	nor	LoCk	oFF
SV : 2000, Bank 0 to 2 : Initialized					

Single display type (※Refer to B-17 to 19 page.)

Sensitivity setting mode

※ There are two methods available for sensitivity setting - manual or teach mode. Select the method most suitable for your application.

Manual sensitivity setting (Fine-adjusting sensitivity)

- The setting value can be directly changed by pressing the manual button
- Used to fine-adjusting sensitivity the sensitivity after teaching.
- Incident light level is still displayed during SV setting.

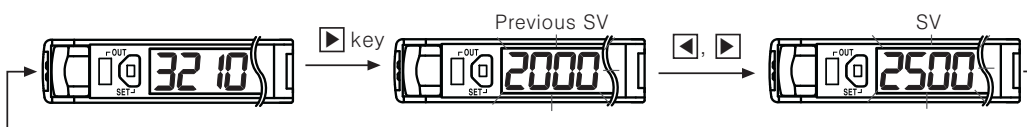

- ① Press **[▶]** key once in RUN mode, then previous SV will be flashing twice (0.5 sec.).
- ② Press **[◀]** and **[▶]** key to set the value.
- ③ If there is no additional key input for 3 sec. after completing setting, newly set value will be flashing twice (0.5 sec. cycle) and automatically returned to RUN mode.

(A)	Photo electric sensor
(B)	Fiber optic sensor
(C)	Door/Area sensor
(D)	Proximity sensor
(E)	Pressure sensor
(F)	Rotary encoder
(G)	Connector/Socket
(H)	Temp. controller
(I)	SSR/Power controller
(J)	Counter
(K)	Timer
(L)	Panel meter
(M)	Tacho/Speed/Pulse meter
(N)	Display unit
(O)	Sensor controller
(P)	Switching power supply
(Q)	Stepping motor & Driver & Controller
(R)	Graphic/Logic panel
(S)	Field network device
(T)	Production stoppage models & replacement

Teaching sensitivity setting(Auto tuning teaching)

- For BF5R-S1-N model, teaching sensitivity setting mode is fixed to auto-tuning teaching.
- ※ Suitable when incident light level of sensing object is not stable or when sensing fast moving objects.
- ※ One of teaching modes that sets the sensitivity using average value of the maximum and minimum incident light level within a certain time period.

$$\text{Set_value} = \frac{P1+P2+\dots+Pn-1+Pn}{n}$$

- In program mode, set Teaching mode parameter [5E05] to [Auto].

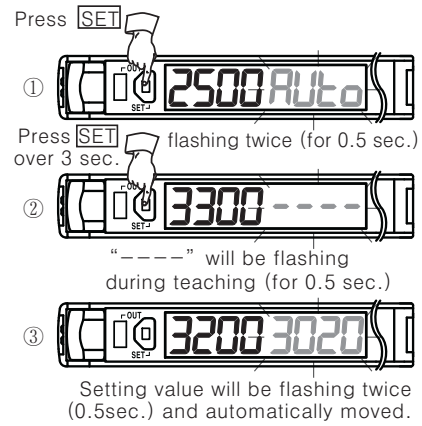
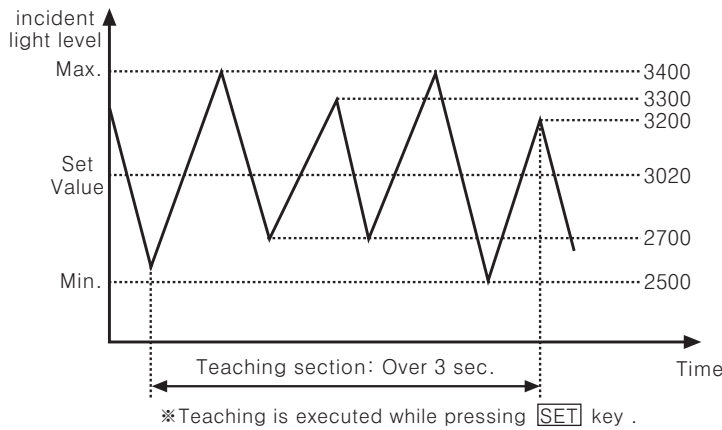

Function

Response time setting

Use front slide switch to set response time.

- Fast mode : 150μs
- Standard mode : 500μs
- Long distance mode : 4ms

Display function (Factory mode: standard display)

A function to select incident light level display on display part.

- Standard mode display range : 0 to 4000 (0 to 9999, in case of long distance mode)
- Percentage mode display range : 0P to 99.9P (No decimal point displayed)
- When changing to standard display mode

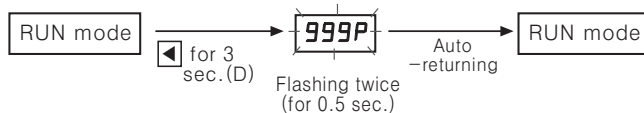

- When changing to percentage display mode

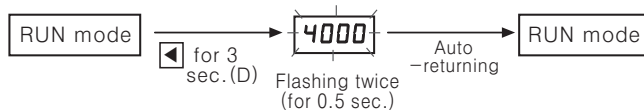

Timer function

※ As for BF5R-S1-N type, off delay mode is provided only. Select setting time (Off / 10ms / 40ms) using front slide switch.

Time chart

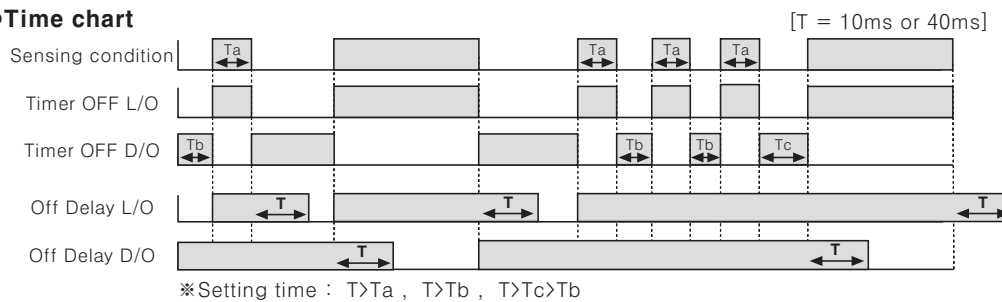

Light ON / Dark ON switching function

A function to set Light ON - control output is ON when incident light level is higher than setting value and Dark ON - control output is ON when incident light level is lower than setting value. BF5R-S1-N(Single display type) use front slide switch to set each mode.

BF5 Series

Group teaching

A function to set the sensitivity of slave amplifier units according to the command of master amplifier unit (certain amplifier unit) in a successive and collective way. *In case of two-point teaching mode, Group teaching is not applicable.

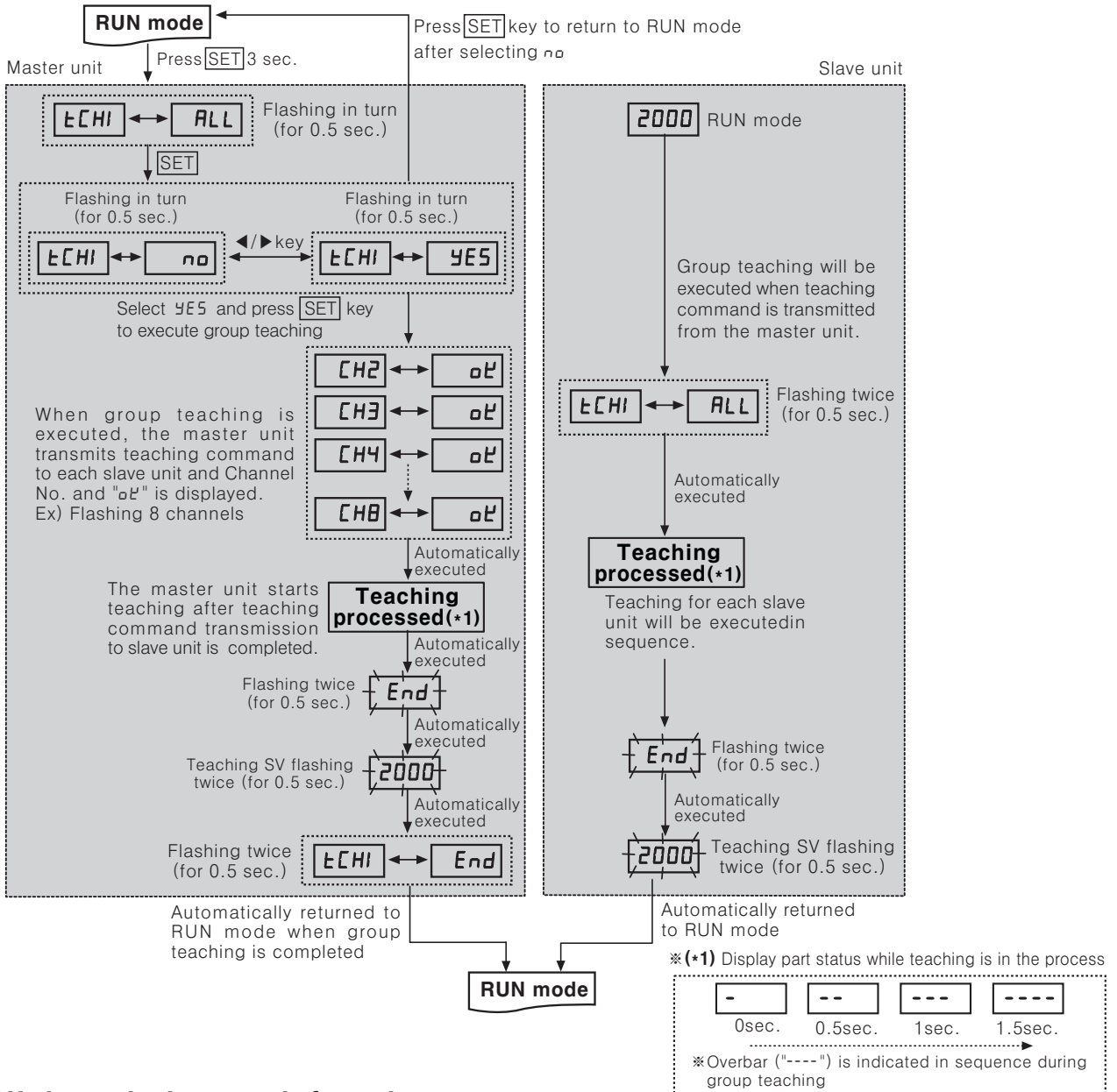

High peak, low peak function

A function to monitor high/low peak value of incident light level / Monitored high/low peak value can be initialized.

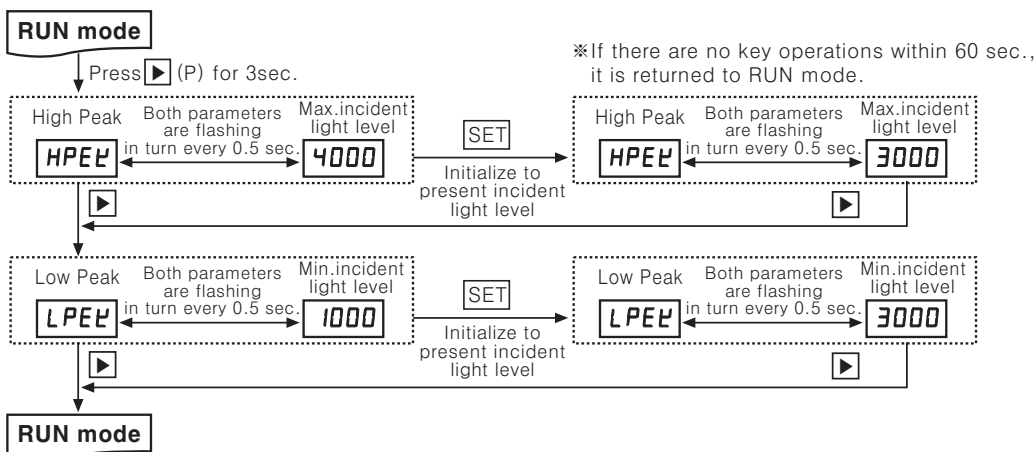

Fiber Optic Amplifier

Dual display / Single display common features

■ Program mode function

○ Amplifier units connection using side connector

In case multiple amplifier units are connected, the power supply for one unit will feed all connected units.

○ Auto channel setting function

- The channel for each amplifier unit – connected by side connector – is automatically set in a certain direction (→) as soon as power is supplied. Channel number is increasing one by one.
 - Auto set channel can be checked in channel parameter in program mode.
 - In case of BF5R-S1-N, auto set channel can be checked only when initial power is supplied. (Not available afterwards).
 - Channel range : 1 to 32 (applied the same to all models)
- ※ **Note that auto set channel cannot be changed and the channel No. of each amplifier unit is not saved in case of power OFF.**

○ Mutual interference prevention function

A function to set different light receiving time for each amplifier unit in case of adjacent fiber cable installations in order to prevent mutual interference occurring. (Set automatically when power is turned ON.)

※ Mutual interference function is allowed up to maximum 8 amplifier units regardless of the unit model and response time.

■ Error code

Error code	Cause	Troubleshooting
<i>ErrL</i>	In case incident light level is below the min. range when teaching	Increase the incident light level above min. range.
<i>Err</i>	In case overcurrent inflow occurs into output circuit.	Remove overcurrent due to overload.
<i>ErB</i>	<ul style="list-style-type: none"> ● In case Slave is failed to execute Master's instructions due to unstable communication line connection during Group Copy / Load / Save / Teaching. ● In case other communication errors occur 	<ul style="list-style-type: none"> ● Check amplifier unit's connection again. ● Check circuit and hardware around side connector.

(A) Photo electric sensor

(B) Fiber optic sensor

(C) Door/Area sensor

(D) Proximity sensor

(E) Pressure sensor

(F) Rotary encoder

(G) Connector/Socket

(H) Temp. controller

(I) SSR/ Power controller

(J) Counter

(K) Timer

(L) Panel meter

(M) Tacho/ Speed/ Pulse meter

(N) Display unit

(O) Sensor controller

(P) Switching power supply

(Q) Stepping motor & Driver & Controller

(R) Graphic/ Logic panel

(S) Field network device

(T) Production stoppage models & replacement