



# *Motion Coordinator - 4xx Range*

HARDWARE REFERENCE MANUAL

Version 7.5

# Trio Motion Technology

## *Motion Coordinator 4xx Range*

### Hardware Reference Manual

Seventh Edition • 2013  
Revision 5

All goods supplied by Trio are subject to Trio's standard terms and conditions of sale.  
This manual applies to systems based on the *Motion Coordinator* MC4 range.

The material in this manual is subject to change without notice. Despite every effort, in a manual of this scope errors and omissions may occur. Therefore Trio cannot be held responsible for any malfunctions or loss of data as a result.

Copyright (C) 2000-2013 Trio Motion Technology Ltd.  
All Rights Reserved

**UK**

Trio Motion Technology Ltd.  
Phone: +44 (0)1684 292333  
Fax: +44 (0)1684 297929

**USA**

Trio Motion Technology LLC.  
Phone: +1 724 540 5018  
Fax: +1 724 540 5098

**CHINA**

Trio Shanghai  
Tel: +86 21 5879 7659  
Fax: +86 21 5879 4289

**INDIA**

Trio India  
Phone: +91 827 506 5441

## SAFETY WARNING

During the installation or use of a control system, users of Trio products must ensure there is no possibility of injury to any person, or damage to machinery. Control systems, especially during installation, can malfunction or behave unexpectedly. Bearing this in mind, users must ensure that even in the event of a malfunction or unexpected behaviour the safety of an operator or programmer is never compromised.

This manual uses the following icons for your reference:



Information that relates to safety issues and critical software information



Information to highlight key features or methods.



Useful tips and techniques.



# Contents

<b>INTRODUCTION TO THE MC4XX RANGE</b> .....	1-3	<i>Motion Coordinator MC403</i> .....	2-20
Typical System Configuration .....	1-3	Overview .....	2-20
Setup and Programming .....	1-4	Programming .....	2-20
Features .....	1-5	I/O Capability .....	2-20
The Trio Motion Technology Website .....	1-6	Communications .....	2-20
<b>HARDWARE</b> .....	2-3	Removable Storage .....	2-21
<i>Motion Coordinator MC464</i> .....	2-3	Axis Positioning Functions .....	2-21
Overview .....	2-3	Connections to the MC403 .....	2-21
Programming .....	2-3	Ethernet Port Connection .....	2-21
I/O Capability .....	2-3	MC403 Serial Connections .....	2-22
Communications .....	2-4	Serial Connector .....	2-22
Removable Storage .....	2-4	MC403 Pulse Outputs / Encoder Inputs .....	2-23
Axis Positioning Functions .....	2-4	Registration .....	2-24
Connections to the MC464 .....	2-5	5-Way Connector .....	2-24
Ethernet Port Connection .....	2-5	I/O Connector 1 .....	2-24
Ethernet Sync Port .....	2-5	24V Input Channels .....	2-24
MC464 Serial Connections .....	2-5	I/O Power Inputs .....	2-24
Serial Connector .....	2-5	24V I/O Channels .....	2-25
Sync Encoder .....	2-6	I/O Connector 2 .....	2-25
Registration .....	2-6	Amplifier Enable (Watchdog) Relay Outputs .....	2-25
24V Power Supply Input .....	2-7	Analogue Inputs .....	2-26
Amplifier Enable (Watchdog) Relay Outputs .....	2-7	Analogue Outputs .....	2-26
CANbus .....	2-8	LED Display .....	2-26
Analogue Inputs .....	2-8	MC403 Feature Summary .....	2-27
24V Input Channels .....	2-8	MC403 Axis Configuration Summary .....	2-28
24V I/O Channels .....	2-8	Configuration Key .....	2-28
Battery .....	2-8	<i>Motion Coordinator MC405</i> .....	2-30
Backlit Display .....	2-9	Overview .....	2-30
MC464 Feature Summary .....	2-11	Programming .....	2-30
<i>Motion Coordinator MC4N-Mini EtherCAT Master</i> .....	2-12	I/O Capability .....	2-30
Overview .....	2-12	Communications .....	2-30
Programming .....	2-12	Removable Storage .....	2-31
I/O Capability .....	2-12	Axis Positioning Functions .....	2-31
Communications .....	2-12	Connections to the MC405 .....	2-31
Removable Storage .....	2-13	Ethernet Port Connection .....	2-31
Axis Positioning Functions .....	2-13	Connector: RJ45 .....	2-32
Connections to the MC4N .....	2-13	MC405 Serial Connections .....	2-32
Ethernet Port Connection .....	2-13	Serial Connector .....	2-32
Serial Connections .....	2-14	MC405 Pulse+direction Outputs / Encoder Inputs .....	2-33
Flexible Axis Port .....	2-14	Registration .....	2-34
EtherCAT Port .....	2-14	5-Way Connector .....	2-34
Amplifier Enable (Watchdog) Relay Output .....	2-16	I/O Connector 1 .....	2-34
5 way CAN connector .....	2-16	I/O Connector 2 .....	2-35
Display .....	2-17	24V Input Channels .....	2-35
Communications Active .....	2-17	I/O Power Inputs .....	2-35
EtherCAT Detection .....	2-17	24V I/O Channels .....	2-35
Error .....	2-18	I/O Connector 3 .....	2-36
Network Set-up .....	2-18	Amplifier Enable (Watchdog) Relay Outputs .....	2-36
MC4N Feature Summary .....	2-19	Analogue Inputs .....	2-36
		Analogue Outputs .....	2-36

Backlit Display .....	2-37	Anybus-CC Module (P875) .....	3-14
MC405 Feature Summary .....	2-38	Anybus Module Fitting.....	3-15
<b>Motion Coordinator Euro404 /408 .....</b>	<b>2-39</b>	<b>GENERAL DESCRIPTION OF I/O MODULES .....</b>	<b>4-3</b>
Overview .....	2-39	Product Code: .....	4-3
Programming .....	2-39	<b>CAN 16-Output Module (P317) .....</b>	<b>4-4</b>
I/O Capability .....	2-39	CANbus .....	4-4
Communications .....	2-39	24V Output Channels .....	4-4
Removable Storage .....	2-39	LED Indicators .....	4-5
Axis Configuration .....	2-40	Configuration Switches .....	4-5
5 Volt Power Supply .....	2-40	Specification P317 .....	4-5
Euro404 / 408 Backplane Connector .....	2-40	<b>CAN 16-Input Module (P318) .....</b>	<b>4-6</b>
Amplifier Enable (Watchdog) Relay Output .....	2-43	CANbus .....	4-6
24V Input Channels .....	2-43	24V Input Channels .....	4-6
24V Output Channels .....	2-44	Configuration Switches .....	4-7
Registration Inputs .....	2-44	Specification P318 .....	4-7
Differential Encoder Inputs .....	2-44	<b>CAN 16-I/O Module (P319) .....</b>	<b>4-8</b>
Voltage Outputs .....	2-44	CANbus .....	4-8
Analogue Inputs .....	2-44	24V Input/ Output Channels .....	4-8
Using End of Travel Limit Sensors .....	2-45	Configuration Switches .....	4-9
Ethernet Port Connection .....	2-45	Specification P319 .....	4-9
Serial Connector B: .....	2-46	<b>CAN Analogue I/O Module (P326) .....</b>	<b>4-10</b>
Euro404 / 408 - Feature Summary .....	2-47	CANbus .....	4-10
<b>MC464 EXPANSION MODULES .....</b>	<b>3-3</b>	Input Terminals.....	4-10
Assembly .....	3-3	Output Terminals .....	4-10
Module SLOT Numbers .....	3-3	LED Indicators .....	4-11
Fitting Expansion Modules .....	3-4	Configuration Switches .....	4-11
<b>RTEX Interface (P871) .....</b>	<b>3-5</b>	Specification P326 .....	4-11
Realtime Express .....	3-5	<b>CAN 8-Relay Module (P327) .....</b>	<b>4-12</b>
RJ45 Connector (tx) .....	3-5	CANbus .....	4-12
RJ45 Connector (Rx) .....	3-5	Relay Channels .....	4-12
Time Based Registration .....	3-5	LED Indicators .....	4-13
Registration connector .....	3-5	Configuration Switches .....	4-13
LED Functions .....	3-6	Specification P327 .....	4-13
<b>Sercos Interface (P872) .....</b>	<b>3-7</b>	<b>Controller I/O mapping .....</b>	<b>4-14</b>
Sercos Connections .....	3-7	Digital I/O order .....	4-14
Connector (Rx) .....	3-7	Analogue I/O order .....	4-14
Connector (Tx) .....	3-7	<b>TrioCANv2 Protocol .....</b>	<b>4-15</b>
Time Based Registration .....	3-7	General Description .....	4-15
<b>SLM Interface (P873) .....</b>	<b>3-9</b>	Protocol Selection .....	4-16
Time Based Registration .....	3-9	Controller Setup .....	4-16
Registration Connector .....	3-10	Update Rates .....	4-16
LED Functions .....	3-10	Digital I/O .....	4-16
<b>FlexAxis Interface (P874 / P879) .....</b>	<b>3-11</b>	Analogue I/O .....	4-17
Encoder Connector .....	3-11	Digital CAN I/O addressing .....	4-17
Multifunction Connector .....	3-12	Analogue I/O addressing .....	4-18
Analogue Outputs .....	3-12	Error codes .....	4-19
Position Based Registration .....	3-12	Digital Input, Output and I/O modules .....	4-19
PSWITCH Outputs .....	3-12	Troubleshooting .....	4-20
Multifunction Connector Pin Out .....	3-12	<b>CANopen DS401 .....</b>	<b>4-21</b>
LED Functions .....	3-13	General Description .....	4-21
<b>EtherCAT Interface (P876) .....</b>	<b>3-13</b>	Protocol Selection .....	4-21
RJ45 Connector .....	3-13	Controller Setup .....	4-22
Time Based Registration .....	3-13	Module Addressing .....	4-22
Registration Connector .....	3-14	Error Codes .....	4-22
LED Functions .....	3-14	LED state definitions .....	4-22

PWR LED error code .....	4-22	Emissions - BS EN61000-6-4 : 2007. ....	6-12
ERR LED error code .....	4-23	Immunity - BS EN61000-6-2 : 2005. ....	6-12
		Requirements For EMC Conformance .....	6-12
<b>INSTALLING HARDWARE .....</b>	<b>5-3</b>	<b>INDEX.....</b>	<b>III</b>
Installing the MC464.....	5-3		
Packaging.....	5-3		
Expandable design .....	5-3		
Items supplied with the MC464 .....	5-4		
Connectors: .....	5-4		
Panel mounting set: .....	5-4		
Mounting MC464.....	5-4		
General .....	5-4		
DIN Rail .....	5-4		
Environmental Considerations .....	5-5		
IP rating: IP 20.....	5-5		
Installing the MC4N.....	5-6		
Packaging.....	5-6		
Items supplied with the MC4N .....	5-6		
Connectors.....	5-6		
Mounting MC4N.....	5-6		
General .....	5-6		
Screw Mounting .....	5-7		
Environmental Considerations .....	5-7		
IP rating: IP 20.....	5-7		
Instalting the MC405 / MC403 .....	5-8		
Packaging.....	5-8		
Items supplied with the MC405 / MC403 .....	5-9		
Connectors.....	5-9		
Mounting MC405 / MC403 .....	5-9		
General .....	5-9		
DIN Rail .....	5-9		
Screw Mounting .....	5-9		
Environmental Considerations .....	5-9		
IP rating: IP 20.....	5-9		
Installing the CAN I/O Modules .....	5-10		
Packaging .....	5-10		
Items Supplied with CAN I/O modules .....	5-10		
Mounting CAN I/O Modules .....	5-10		
Environmental Considerations .....	5-11		
IP rating: IP 20 .....	5-11		
Bus Wiring.....	5-11		
<b>EMC CONSIDERATIONS .....</b>	<b>6-3</b>		
EMC Earth - MC464 .....	6-4		
EMC Earth - MC4N .....	6-5		
EMC Earth - MC405 / MC403 .....	6-6		
EMC Earth - CAN I/O Modules.....	6-7		
Cable Shields .....	6-8		
Surge protection .....	6-8		
Single power supply.....	6-9		
Distributed Power supply .....	6-9		
Recommended protection device .....	6-9		
MC464 and IO devices .....	6-10		
MC403/MC405.....	6-11		
Background to EMC Directive .....	6-11		
Testing Standards .....	6-11		





# INTRODUCTION

1



# Introduction to the MC4xx Range

The MC4 range *Motion Coordinators* are the latest in the Trio pedigree representing over 25 years of motion control experience. Run your machine faster and with greater precision with these new generation *Motion Coordinators* based on a 64 bit technology.

Choose the motor and drives to best suit your application without compromise, the MC4xx range provides interface options for traditional servo, stepper and piezo control together with many digital interfaces for current digital servo drives. Increase the flexibility of your equipment with support for up to 64 axes of motion control. Trio's tradition of modular configuration has evolved into convenient MC464 clip-on modules allowing the system designer to precisely build the configuration needed for the job.

The MC405 and MC403 share the same advanced software and hardware techniques with the MC464, but come in 2 compact and cost-effective packages for machine applications requiring lower axis counts.

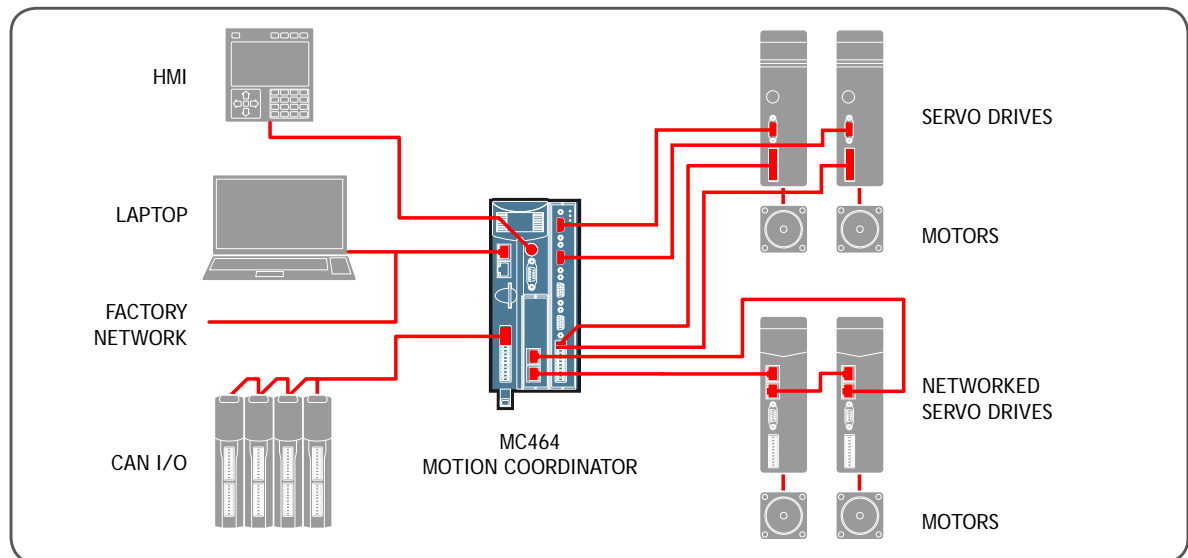

*Typical System Configuration*

## TYPICAL SYSTEM CONFIGURATION

The MC4 range supports programs written in TrioBASIC, allowing a smooth upgrade path from earlier types of *Motion Coordinator*. In addition, the standard IEC 61131-3 languages are supported, allowing both logical I/O and motion programming in Ladder, Function Block, Structured Text and Sequential Function Chart. A rich set of motion function blocks allows the programmer to have full access to the familiar Trio Motion command set.

I/O expansion is provided via a built-in CANbus interface. The built-in Ethernet port supports both the programming interface and many Ethernet based fieldbuses. These can be used simultaneously. Further fieldbus networks supporting common factory protocols are supported in the MC464 via the HMS AnyBus® adapter module.

The MC464 axis expansion modules feature many options for Drive Network interfaces, analogue servo, pulse/direction, absolute or incremental feedback and accurate hardware registration. Up to 7 half-height expansion modules or 3 full-height expansion modules can be attached. This modular approach along with Trio's feature enable code system for axis activation allows the whole system to be scaled exactly to need.

The MC4N is dedicated to running remote servo and stepper drives via the EtherCAT real time automation bus. Versions of the MC4N are available for 2, 4, 8, 16 and 32 motor axes

The MC403 and MC405 each come in 2 main variants; either 3 or 5 axis pulse+direction output, or as 2 or 4 axis servo with a single 5th axis encoder port.

## SETUP AND PROGRAMMING

To program the *Motion Coordinator*, a PC is connected via an Ethernet link. The dedicated *Motion Perfect* program is normally used to provide a wide range of programming facilities on a PC running Microsoft Windows XP, Vista or Windows 7 versions.

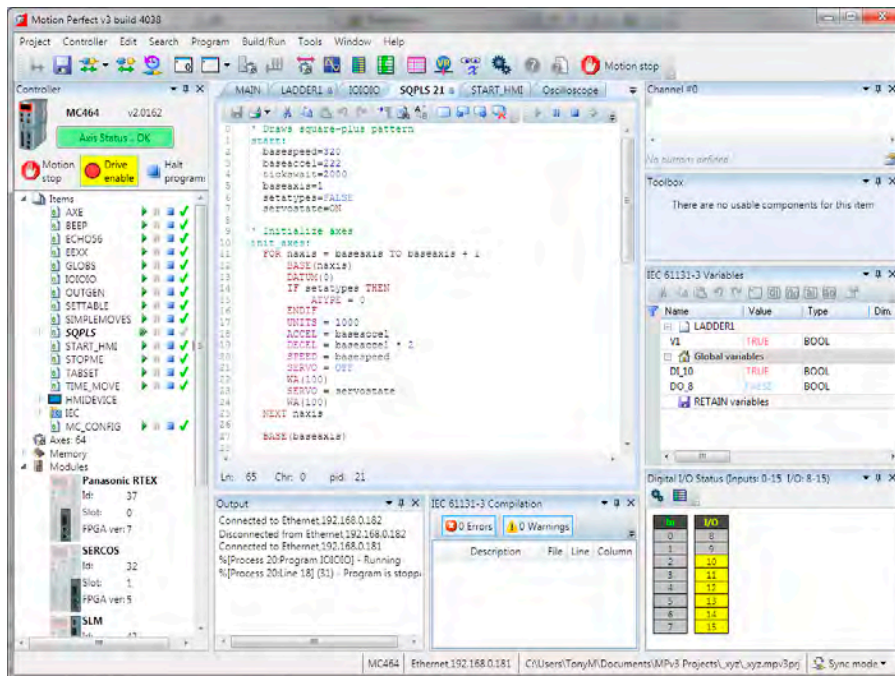

*Motion Perfect 3*

Once connected to the *Motion Coordinator*, the user has direct access to TrioBASIC which provides an easy and rapid way to develop control programs. All the standard program constructs are provided; variables, loops, input/output, maths and conditions. Extensions to this basic instruction set exist to permit a wide variety of motion control facilities, such as single axis moves, synchronised multi axis moves and unsynchronised multi axis moves as well as the control of the digital I/O.

The MC4 range features multi-tasking TrioBASIC and the standard IEC 61131-3 language. Multiple TrioBASIC programs plus Ladder Diagram (LD), Function Block (FB), Structured Text (ST) and Sequential Function

Chart (SFC) can be constructed and run simultaneously to make programming complex applications much easier. *Motion Perfect* version 3 is needed to access the full IEC 61131-3 functionality. MPv3 provides a seamless programming, compilation and debug environment that can work in real-time with any of the MC4 range *Motion Coordinators*. A motion library is provided which enables the familiar Trio Motion Technology commands to be included in IEC 61131-3 programs.

## FEATURES

- Supports digital drive systems up to 64 axis
- Based on 64bit MIPS and ARM processor technology
- 64bit position integers
- High accuracy double floating point resolution
- Multi-tasking BASIC programming
- IEC61131-3 programming support
- Motion buffers up to 64 moves
- Robotics, gears, interpolation and synchronisation built-in
- I/O expansion up to 528 I/O points
- Ethernet programming interface
- Backlit LCD display (MC464, MC4N and MC405)
- Expansion flexibility with clip on modules allowing quick interchangeability (MC464 only)
- Anybus Module support allowing flexible factory communication options (MC464 only)

## THE TRIO MOTION TECHNOLOGY WEBSITE

The Trio website contains up to the minute news, information and support for the *Motion Coordinator* product range.

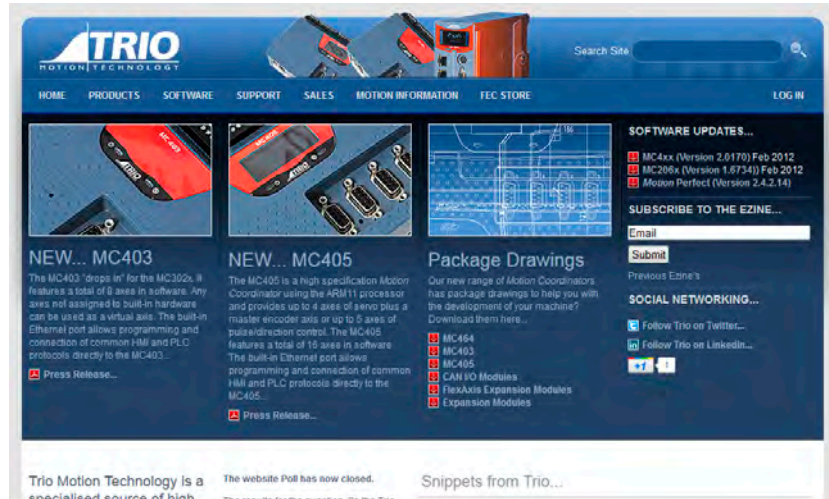

- Website Features
- Latest News
- Product Information
- Manuals
- Programming Tools
- System Software Updates
- Technical Support
- User's Forum
- Application Examples
- Employment Opportunities

WWW.TRIOACTION.COM







# HARDWARE OVERVIEW

2



# Hardware

## Motion Coordinator MC464

### OVERVIEW

The *Motion Coordinator MC464* is Trio's new generation modular servo control positioner with the ability to control servo or stepper motors by means of Digital Drive links (e.g. EtherCAT, Sercos, etc) or via traditional analogue and encoder or pulse and direction. A maximum of 7 expansion modules can be fitted to control up to 64 axes which gives the flexibility required in modern system design. The MC464 is housed in a rugged plastic case with integrated earth chassis and incorporates all the isolation circuitry necessary for direct connection to external equipment in an industrial environment. Filtered power supplies are included so that it can be powered from the 24V d.c. logic supply present in most industrial cabinets.

It is designed to be configured and programmed for the application using a PC running the *Motion Perfect* application software, and then may be set to run "standalone" if an external computer is not required for the final system.

The Multi-tasking version of TrioBASIC for the MC464 allows up to 22 TrioBASIC programs to be run simultaneously on the controller using pre-emptive multi-tasking. In addition, the operating system software includes the IEC 61131-3 standard run-time environment (licence key required).

### PROGRAMMING

The Multi-tasking ability of the MC464 allows parts of a complex application to be developed, tested and run independently, although the tasks can share data and motion control hardware. IEC 61131-3 programs can be run at the same time as TrioBASIC allowing the programmer to select the best features of each.

### I/O CAPABILITY

The MC464 has 8 built in 24V inputs and 8 bi-directional I/O channels. These may be used for system interaction or may be defined to be used by the controller for end of travel limits, registration, datuming and feedhold functions if required. Each of the Input/Output channels has a status indicator to make it easy to check them at a glance. The MC464 can have up to 512 external Input/Output channels connected using DIN rail mounted CAN I/O modules. These units connect to the built-in CAN channel.



## COMMUNICATIONS

A 10/100 base-T Ethernet port is fitted as standard and this is the primary communications connection to the MC464. Many protocols are supported including Telnet, Modbus TCP, Ethernet IP and TrioPCMotion. Check the Trio website ([www.triomotion.com](http://www.triomotion.com)) for a complete list.

The MC464 has one built in RS232 port and one built in duplex RS485 channel for simple factory communication systems. Either the RS232 port or the RS485 port may be configured to run the Modbus or Hostlink protocol for PLC or HMI interfacing.

If the built-in CAN channel is not used for connecting I/O modules, it may optionally be used for CAN communications. E.g. DeviceNet slave or CANopen master.

The Anybus CompactCom Carrier Module (P875) can be used to add other fieldbus communications options

## REMOVABLE STORAGE

The MC464 has a SD Card slot which allows a simple means of transferring programs, firmware and data without a PC connection. Offering the OEM easy machine replication and servicing.

The memory slot is compatible with a wide range of SD cards up to 2Gbytes using the FAT32 compatible file system.



## AXIS POSITIONING FUNCTIONS

The motion control generation software receives instructions to move an axis or axes from the TrioBASIC or IEC 61131-3 language which is running concurrently on the same processor. The motion generation software provides control during operation to ensure smooth, coordinated movements with the velocity profiled as specified by the controlling program. Linear interpolation may be performed on groups of axes, and circular, helical or spherical interpolation in any two/three orthogonal axes. Each axis may run independently or they may be linked in any combination using interpolation, CAM profile or the electronic gearbox facilities.

Consecutive movements may be merged to produce continuous path motion and the user may program the motion using programmable units of measurement (e.g. mm, inches, revs etc.). The module may also be programmed to control only the axis speed. The positioner checks the status of end of travel limit switches which can be used to cancel moves in progress and alter program execution.

## CONNECTIONS TO THE MC464

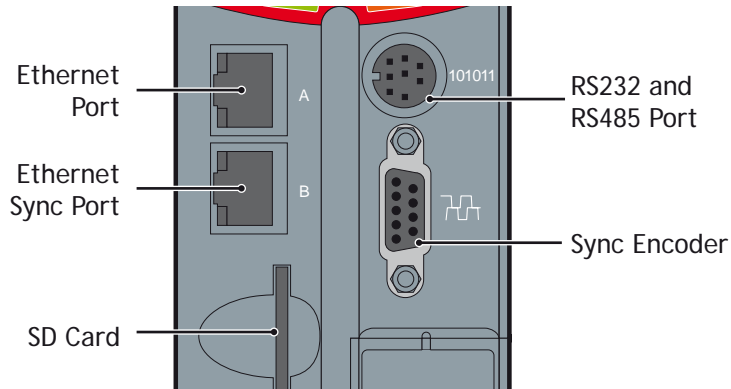

### ETHERNET PORT CONNECTION

Physical layer: 10/100 base\_T

Connector: RJ45

The Ethernet port is the default connection between the *Motion Coordinator* and the host PC running *Motion Perfect* programming.

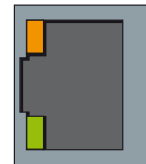

### ETHERNET SYNC PORT

Not used.

### MC464 SERIAL CONNECTIONS

The MC464 features two serial ports. Both ports are accessed through a single 8 pin connector.

### SERIAL CONNECTOR

Pin	Function	Note
1	RS485 Data In A Rx+	Serial Port #2
2	RS485 Data In B Rx-	
3	RS232 Transmit	Serial Port #1
4	0V Serial	
5	RS232 Receive	Serial Port #1
6	Internal 5V	5V supply is limited to 150mA, shared with sync port
7	RS485 Data Out Z Tx-	Serial Port #2
8	RS485 Data Out Y Tx+	Serial Port #2

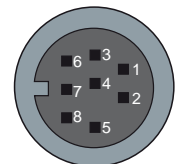

## SYNC ENCODER

The sync encoder port is bidirectional. It can be used as a reference encoder input or as an encoder simulation output to act as a master reference for other parts of the system.

Pin	Function	Pulse & Direction
1	Enc. A	Step+
2	Enc. /A	Step-
3	Enc. B	Direction+
4	Enc. /B	Direction-
5	0V Encoder	0V Stepper
6	Enc. Z	Enable+
7	Enc. /Z	Enable-
8	5V *	5V*
9	5V Registration input	5V Registration input



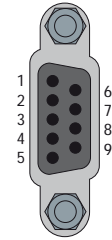



























\*5V supply is limited to 150mA (shared with serial port)



## REGISTRATION

The MC464 built in port has 2 available registration events. These can be used with the Z mark, the registration input on the sync port, input 0 or input 1.

**24V POWER SUPPLY INPUT**

0V AIN			0V CAN/AIN
AIN0			CAN LOW
AIN1			CAN SHIELD
WDOG+			CAN HIGH
WDOG-			24V CAN/AIN SUPPLY
I 0			I/O/8
I 1			I/O/9
I 2			I/O/10
I 3			I/O/11
I 4			I/O/12
I 5			I/O/13
I 6			I/O/14
I 7			I/O/15
0V I/O			24V I/O SUPPLY
0V SUPPLY			24V SUPPLY

The MC464 is powered entirely via the 24V d.c. supply connections. The unit uses internal DC-DC converters to generate independent 5V logic supply, the encoder/serial 5V supply and other internal power supplies. I/O, analogue and CANbus circuits are isolated from the main 24V power input and must be powered separately. For example; it is often necessary to power the CANbus network remotely via the CANbus cable.



24V d.c., Class 2 transformer or power source required for UL compliance. The MC464 is grounded via the metal chassis. It MUST be installed on an unpainted metal plate or DIN rail which is connected to earth.

**AMPLIFIER ENABLE (WATCHDOG) RELAY OUTPUTS**

One internal relay contact is available to enable external amplifiers when the controller has powered up correctly and the system and application software is ready. The amplifier enable is a solid-state relay with an ON resistance of 25 ohms at 100mA. The enable relay will be open circuit if there is no power on the controller OR a motion error exists on a servo axis OR the user program sets it open with the **WDOG=OFF** command.

The amplifier enable relay may, for example, be incorporated within a hold-up circuit or chain that must be intact before a 3-phase power input is made live.



**ALL STEPPER AND SERVO AMPLIFIERS MUST BE INHIBITED WHEN THE AMPLIFIER ENABLE OUTPUT IS OPEN CIRCUIT**



## CANBUS

The MC464 features a built-in CAN channel. This is primarily intended for Input/Output expansion via Trio's range of CAN digital and analogue I/O modules. It may be used for other purposes when I/O expansion is not required.

The CANbus port is electrically equivalent to a DeviceNet node.

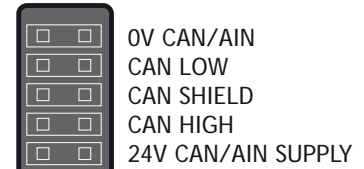

## ANALOGUE INPUTS

Two built-in 12 bit analogue inputs are provided which are set up with a scale of 0 to 10V. External connection to these inputs is via the 2-part terminal strip on the lower front panel.

A 24V d.c. supply must be applied to the CANbus port to provide power for the analogue input circuit.

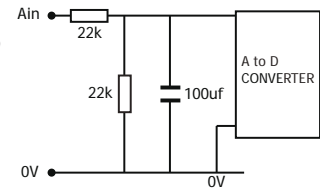

## 24V INPUT CHANNELS

The *Motion Coordinator* has 16 24V Input channels built into the master unit. These may be expanded to 256 Inputs by the addition of CAN-16 I/O modules.

All of the 24V Input channels have the same circuit although 8 on the master unit have 24V Output channels connected to the same pin. These bi-directional channels may be used for Input or Output to suit the application. If the channel is to be used as an Input then the Output should not be switched on in the program.

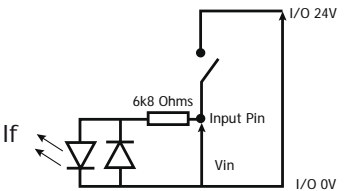

## 24V I/O CHANNELS

Input/output channels 8..15 are bi-directional and may be used for Input or Output to suit the application. The inputs have a protected 24V sourcing output connected to the same pin. If the channel is to be used as an Input then the Output should not be switched on in the program. The input circuitry is the same as on the dedicated inputs. The output circuit has electronic over-current protection and thermal protection which shuts the output down when the current exceeds 250mA.

Care should be taken to ensure that the 250mA limit for the output circuit is not exceeded, and that the total load for the group of 8 outputs does not exceed 1A

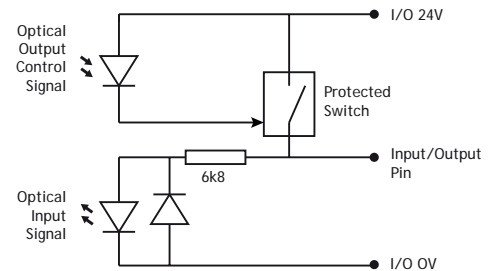

## BATTERY

The MC464 incorporates a user replaceable battery for the battery back-up RAM. For replacement, use battery model CR2450 or equivalent.

To replace the battery, insert screwdriver under the frontmost ventilation slot (A) and prize off the battery cover (B) and pull the battery ribbon to lift the battery (C) from the MC464. Replacing is the reverse of the procedure.

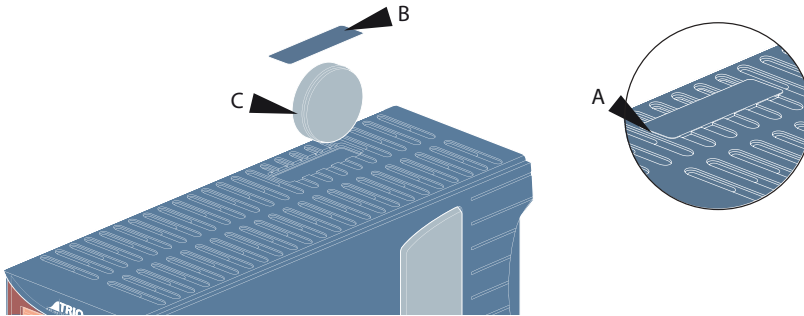

**TO AVOID LOSING THE MEMORY CONTENTS, THE NEW BATTERY SHOULD BE INSERTED WITHIN 30 SECONDS OF THE OLD ONE BEING REMOVED.**

## BACKLIT DISPLAY

The information display area shows the IP address and subnet mask during power-up and whenever an Ethernet cable is first connected to the MC464. During operation, this display shows run, Off or Err to indicate the MC464 status. Below the main status display are the ERROR, ENABLE and BATTERY LOW indicators.

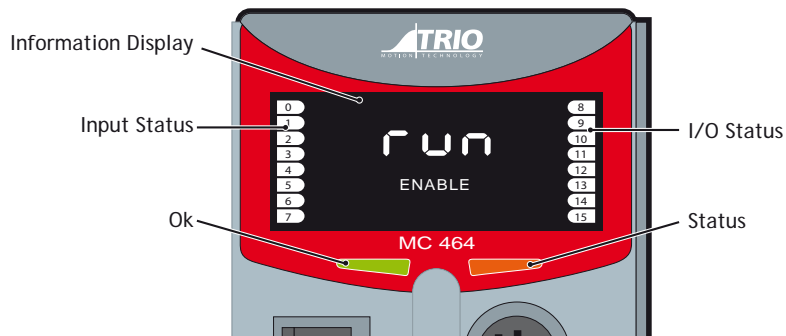

**ERROR**

An error has occurred (see Error Display Codes table below for details).

**ENABLE**

When illuminated, WDOG is ON.

**BATTERY LOW**

When illuminated the battery needs replacing.

A bank of 8 indicators at the left side shows the Digital Input States and a similar bank on the right shows the state of I/O8 to I/O15. The I/O displayed can be altered using the **DISPLAY** command.

Two LED's are provided to show the processor (OK) and system status.

Error Display Codes		
Unn	Unit error on slot nn	
Ann	Axis error on axis aa	
Caa	Configuration error on unit aan	ie: too many axes
Exx	System error	E00 - RAM error 8bit BB - RAM (VR) E01 - RAM error 16 bit BB - RAM (TABLE) E03 - Battery Error E04 - VR/TABLE corrupt entry E05 - Invalid MC_CONFIG file E06 - Started in SAFE mode

**MC464 FEATURE SUMMARY**

Size	201 mm x 56 mm x 155 mm (HxWxD).
Weight	750g
Operating Temp.	0 - 45 degrees C.
Control Inputs	Forward Limit, Reverse Limit, Datum Input, Feedhold Input.
Communication Ports	RS232 channel: up to 38400 baud. RS485 channel: up to 38400 baud. CANbus port (DeviceNet and CANopen compatible) Ethernet: 10/100 BaseT multiple port connection.
Position Resolution	64 bit position count.
Speed Resolution	32 bits. Speed may be changed at any time. Moves may be merged.
Servo Cycle	125µs minimum, 1ms default, 2ms max.
Programming	Multi-tasking TrioBASIC system, maximum 20 user processes. IEC 61131-3 programming system.
Interpolation modes	Linear 1-64 axes, circular, helical, spherical, CAM Profiles, speed control, electronic gearboxes.
Memory	8 Mbyte user memory. 2 Mbyte TABLE battery-backed memory. Automatic flash EPROM program storage.
Table	512,000 table positions. 196,608 positions in battery backed memory.
VR	65,536 VR positions in battery backed memory.
SD Card	Standard SD Card compatible to 2Gbytes. Used for storing programs and/or data.
Power Input	24V d.c., Class 2 transformer or power source. 18..29V d.c. at 625mA typical.
Amplifier Enable Output	Normally open solid-state relay rated 24V ac/dc nominal. Maximum load 100mA. Maximum voltage 29V.
Analogue Inputs	2 isolated x 12 bit 0 to 10V.
Serial / Encoder Power Output	5V at 150mA.
Digital Inputs	8 Opto-isolated 24V inputs.
Digital I/O	8 Opto-isolated 24V outputs. Current sourcing (PNP) 250 mA. (max. 1A per bank of 8).

# Motion Coordinator MC4N-Mini EtherCAT Master

## OVERVIEW

The MC4N is a new concept in high performance *Motion Coordinators* which is dedicated to running remote servo and stepper drives via the EtherCAT real time automation bus. It is based on an up-rated version of the 532MHz ARM 11 processor which makes it ideal for high axis count machines or robotic applications.

It is designed to be configured and programmed for the application using a PC running the *Motion Perfect* application software, and then may be set to run “standalone” if an external computer is not required for the final system.

The Multi-tasking version of TrioBASIC for the MC4N allows up to 22 TrioBASIC programs to be run simultaneously on the controller using pre-emptive multi-tasking. In addition, the operating system software includes the IEC 61131-3 standard run-time environment (licence key required).

Versions of the MC4N are available for 2, 4, 8, 16 and 32 motor axes. All versions feature 32 software axes any of which may be used as virtual axes if not assigned to EtherCAT hardware.

## PROGRAMMING

The Multi-tasking ability of the MC4N allows parts of a complex application to be developed, tested and run independently, although the tasks can share data and motion control hardware. IEC 61131-3 programs can be run at the same time as TrioBASIC allowing the programmer to select the best features of each.

## I/O CAPABILITY

The MC4N has 8 built in 24V inputs and 8 bi-directional I/O channels. These may be used for system interaction or may be defined to be used by the controller for end of travel limits, registration, datuming and feedhold functions if required. Each of the Input/Output channels has a status indicator to make it easy to check them at a glance. The MC4N can have up to 512 external Input/Output channels connected using DIN rail mounted CAN I/O modules. These units connect to the built-in CAN channel.

## COMMUNICATIONS

A 10/100 base-T Ethernet port is fitted as standard and this is the primary communications connection to the MC4N. Many protocols are supported including Telnet, Modbus TCP, Ethernet IP and TrioPCMotion. Check the Trio website ([www.triomotion.com](http://www.triomotion.com)) for a complete list.



The MC4N has one built in RS232 port and one built in duplex RS485 channel for simple factory communication systems. Either the RS232 port or the RS485 port may be configured to run the Modbus or Hostlink protocol for PLC or HMI interfacing.

If the built-in CAN channel is not used for connecting I/O modules, it may optionally be used for CAN communications. E.g. DeviceNet slave or CanOpen master.

## REMOVABLE STORAGE

The SD Card maybe used for storing or transferring programs, recipes and data to and from the MC4N. The card must be FAT32 format and a maximum 16Gb size.



**SD CARDS MAY BE FAT16 FORMATTED WHEN PURCHASED. RE-FORMAT IN A PC TO FAT32 PRIOR TO USE.**

## AXIS POSITIONING FUNCTIONS

The motion control generation software receives instructions to move an axis or axes from the TrioBASIC or IEC 61131-3 language which is running concurrently on the same processor. The motion generation software provides control during operation to ensure smooth, coordinated movements with the velocity profiled as specified by the controlling program. Linear interpolation may be performed on groups of axes, and circular, helical or spherical interpolation in any two/three orthogonal axes. Each axis may run independently or they may be linked in any combination using interpolation, CAM profiles or the electronic gearbox facilities.

Consecutive movements may be merged to produce continuous path motion and the user may program the motion using programmable units of measurement (e.g. mm, inches, revs etc.). The module may also be programmed to control only the axis speed. The positioner checks the status of end of travel limit switches which can be used to cancel moves in progress and alter program execution.

## CONNECTIONS TO THE MC4N

### ETHERNET PORT CONNECTION

Physical layer: 10/100 base\_T

Connector: RJ45

A standard Ethernet connector is provided for use as the primary programming interface.

The Trio programming software, *Motion Perfect*, must be installed on a Windows based PC that is fitted with an Ethernet connection. The IP address is displayed on the MC4N display for a few seconds after power-up or when an Ethernet cable is plugged in.



Ethernet cable must be CAT 5 or better.

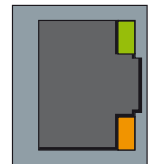

The Standard Ethernet connection may also be used for Ethernet-IP, Modbus and other factory communications.

**SERIAL CONNECTIONS**

Pin	Function	Note
1	RS485 Data In A Rx+	Serial Port #2
2	RS485 Data In B Rx-	
3	RS232 Transmit	Serial Port #1
4	0V Serial	
5	RS232 Receive	Serial Port #1
6	5V Output	150mA max (Current shared with encoder port)
7	RS485 Data Out Z Tx-	Serial Port #2
8	RS485 Data Out Y Tx+	

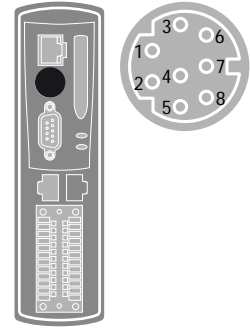
**FLEXIBLE AXIS PORT**

Pin	Encoder	Stepper Axis	Absolute Encoder
1	Enc. A	Step +	Clock
2	Enc. /A	Step -	/Clock
3	Enc. B	Direction +	-----
4	Enc. /B	Direction -	-----
5	0V	0V	0V Enc.
6	Enc. Z	Enable +	Data
7	Enc. /Z	Enable -	/Data
8	5V*	5V*	5V*
9	Not Connected	Not Connected	Not Connected

\*Current limit is 150mA max.

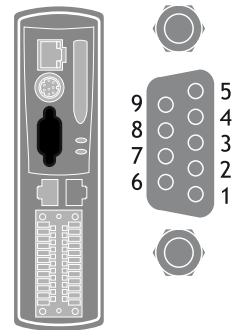
**ETHERCAT PORT**

The MC4N acts as an EtherCAT master. EtherCAT drives and I/O devices are normally connected in a chain. Other topologies are possible when specialised EtherCAT routers are used in the network.

Up to 32 EtherCAT axes and 1024 digital I/O points may be connected via the EtherCAT bus.

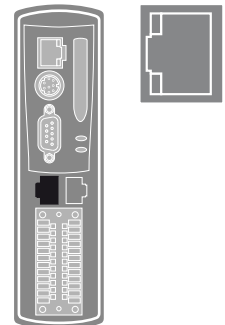

## I/O CONNECTOR

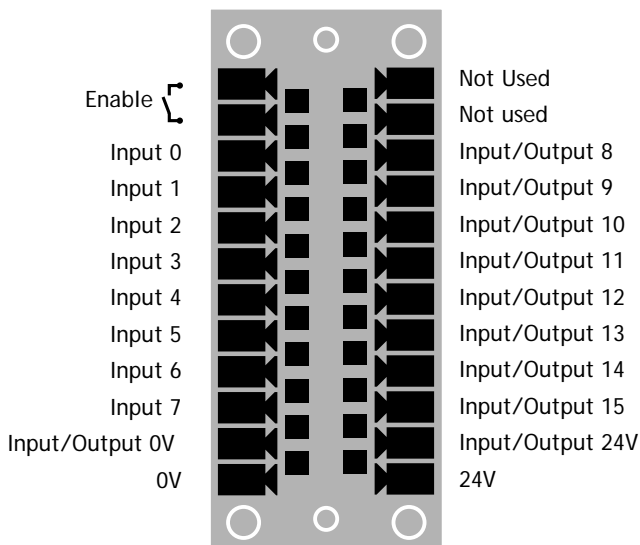

Inputs 0 - 3 have fast opto-couplers for use as axis registration inputs.

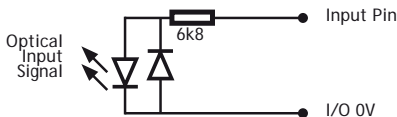

Inputs / Outputs 8 - 15

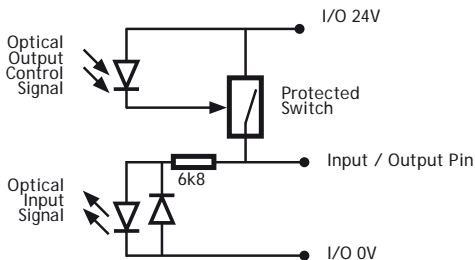

**⚠ THE MC4N IS GROUNDED VIA THE METAL CHASSIS. FIT A SHORT SHIELD CONNECTION BETWEEN THE CHASSIS EARTH SCREW AND THE EARTHED METAL MOUNTING PANEL / PLATE.**



## AMPLIFIER ENABLE (WATCHDOG) RELAY OUTPUT

An internal relay may be used to enable external amplifiers when the controller has powered up correctly and the system and application software are ready. The amplifier enable is a single pole solid state relay with a normally open “contact”. The enable relay contact will be open circuit if there is no power on the controller OR an axis error exists OR the user program sets it open with the **WDOG=OFF** command.

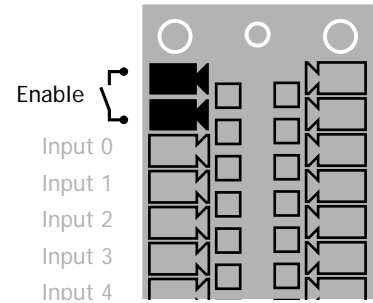

**ETHERCAT DRIVES WILL BE ENABLED VIA THE ETHERCAT NETWORK SO THE “AMPLIFIER ENABLE” CONNECTION IS NOT NORMALLY REQUIRED.**

**ALL NON ETHERCAT STEPPER AND SERVO AMPLIFIERS MUST BE INHIBITED WHEN THE AMPLIFIER ENABLE OUTPUT IS OPEN CIRCUIT**

**AN ADDITIONAL SAFETY RELAY MAY BE REQUIRED SO AS TO MEET MACHINE SAFETY APPROVALS.**

## 5 WAY CAN CONNECTOR

This is a 5 way 3.5mm pitch connector. The connector is used both to provide the 24 Volt power to the MC4N CAN circuit and provide connections for I/O expansion via Trio’s CAN I/O expanders. A 24V dc, Class 2 transformer or power source should be used.

This 24 Volt input is internally isolated from the I/O 24 Volts and main 24V power.

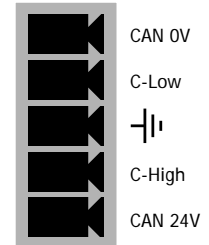

The CAN connector may be left unused.

## DISPLAY

The IP address and subnet mask of the MC4N is shown on the LCD display for a few seconds after power-up. The factory default IP address is 192.168.0.250. This can be changed using the **IP \_ ADDRESS** commands via the *Motion Perfect* software tool.

Display Example	Description	Details
SYS	Displayed on controller start	
901	Model code : Displayed on power up	P901 : 2 axes P902 : 4 axes P903 : 8 axes P904 : 16 axes P905 : 32 axes
192.168.0.250	IP Address :	Displayed on power up OR after ethernet connection for 15 seconds
Unn	Unit error on slot nn	
Ann	Axis error on axis nn	
Caa	Configuration error on unit aa	ie: too many axes
Run / Off	Enable status	
Err xx	Error codes	E00 - RAM error 8bit BB - RAM (VR) E01 - RAM error 16 bit BB - RAM (TABLE) E03 - Battery Error E04 - VR/TABLE corrupt entry E05 - Invalid MC_CONFIG file E06 - Started in SAFE mode

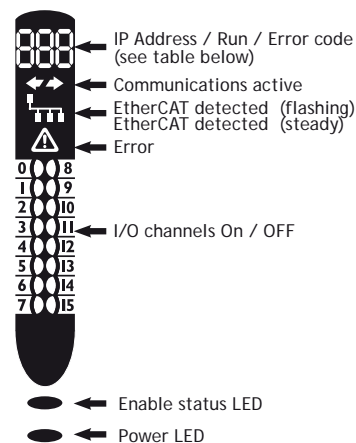

## COMMUNICATIONS ACTIVE

← → This symbol appears when the firmware has detected one or more valid EtherCAT nodes on the network.

## ETHERCAT DETECTION

← → This symbol shows the EtherCAT connection status.

Indicator	EtherCAT State
Flashing	INIT, PRE-OP or SAFE-OP
Steady	OPERATIONAL

**ERROR**

This symbol shows when an error condition has occurred. See the numerical display for more information.

**NETWORK SET-UP****NETWORK CONNECTION**

Set **IP \_ ADDRESS** in MC4N to an available unused address. It **MUST** match the subnet in use. Set the PC to use **DHCP** server.

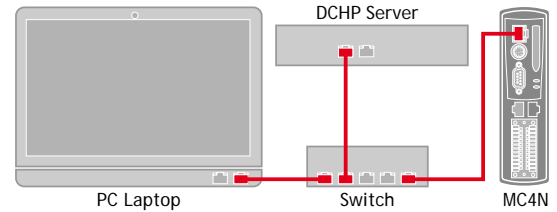

The MC4N always has a fixed **IP \_ ADDRESS**.

**POINT-TO-POINT OR CLOSED NETWORK**

(No DHCP server)



**THE PC MUST BE SET TO A FIXED IP \_ ADDRESS.**

The first 3 “octets” **MUST** be the same as the MC4N and the last **MUST** be different, but not 000, 254 or 255.

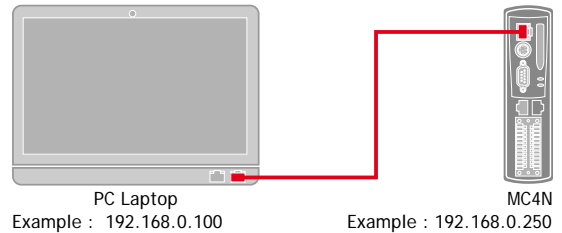
**SETTING A FIXED IP ADDRESS**

In Windows 7. Open “Network and Sharing Centre” then change “Adapter Settings”. Select the properties of the Local Area Network and the IPv4 properties. The IP Address is set to 192.168.0.100 with subnet mask set to 255.255.255.0. Assuming that the MC4N has **IP \_ ADDRESS=192.168.0.250** or similar.

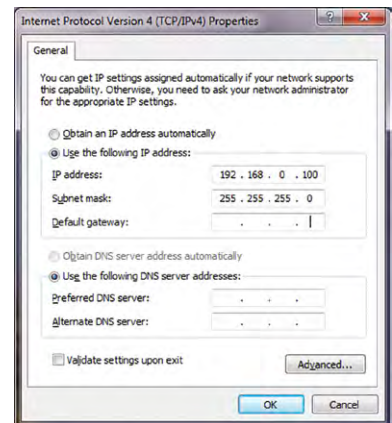

**MC4N FEATURE SUMMARY**

Size	153 mm x 38 mm x 120 mm (HxWxD).
Weight	432g
Operating Temp.	0 - 45 degrees C.
Control Inputs	Forward Limit, Reverse Limit, Datum Input, Feedhold Input.
Communication Ports	RS232 channel: up to 38400 baud. RS485 channel: up to 38400 baud. CANbus port (DeviceNet and CANopen compatible) Ethernet: 10/100 BaseT multiple port connection. EtherCAT Port Flexible Axis Port
Position Resolution	64 bit position count.
Speed Resolution	32 bits. Speed may be changed at any time. Moves may be merged.
Servo Cycle	125µs minimum, 1ms default, 2ms max.
Programming	Multi-tasking TrioBASIC system, maximum 22 user processes. IEC 61131-3 programming system.
Interpolation modes	Linear 1-32 axes, circular, helical, spherical, CAM Profiles, speed control, electronic gearboxes.
Memory	8 Mbyte user memory. 2 Mbyte TABLE battery-backed memory. Automatic flash EPROM program storage.
Table	512,000 table positions.
VR	4096 stored in flash memory.
SD Card	Standard SD Card (FAT 32) compatible to 16Gbytes. Used for storing programs and/or data.
Power Input	24V d.c., Class 2 transformer or power source. 18..29V d.c. at 625mA typical.
Amplifier Enable Output	Normally open solid-state relay rated 24V ac/dc nominal. Maximum load 100mA. Maximum voltage 29V.
Serial / Encoder Power Output	5V at 150mA.
Digital Inputs	8 Opto-isolated 24V inputs.
Digital I/O	8 Opto-isolated 24V outputs. Current sourcing (PNP) 250 mA. (max. 1A per bank of 8).
Product Codes	P900 : MC4N 2 Axis P901 : MC4N 4 Axis P902 : MC4N 8 Axis P903 : MC4N 16 Axis P904 : MC4N 32 Axis

# Motion Coordinator MC403

## OVERVIEW

The *Motion Coordinator MC403* is based on Trio's high-performance ARM11 double-precision technology and provides 2 axes of servo plus a master encoder axis, or 3 axes of pulse+direction control for stepper drives or pulse-input servo drives. Trio uses advanced FPGA techniques to reduce the size and fit the pulse output and servo circuitry in a compact DIN-rail mounted package. The MC403 is housed in a rugged plastic case with integrated earth chassis and incorporates all the isolation circuitry necessary for direct connection to external equipment in an industrial environment. Filtered power supplies are included so that it can be powered from the 24V d.c. logic supply present in most industrial cabinets.

It is designed to be configured and programmed for the application using a PC running Trio's *Motion Perfect* application software, and then may be set to run "standalone" if an external computer is not required for the final system. Programs and data are stored directly to Flash memory, thus eliminating the need for battery backed storage.

The Multi-tasking version of TrioBASIC for the MC403 allows up to 6 TrioBASIC programs to be run simultaneously on the controller using pre-emptive multi-tasking. In addition, the operating system software includes a the IEC 61131-3 standard run-time environment (licence key required).

A reduced functionality version, the MC403-Z has all the features of the full MC403 except that there are no analogue outputs and the encoder function of axes 0 and 1 is incremental encoder only.

## PROGRAMMING

The Multi-tasking ability of the MC403 allows parts of a complex application to be developed, tested and run independently, although the tasks can share data and motion control hardware. The 6 available tasks can be used for TrioBASIC or IEC 61131-3 programs, or a combination of both can be run at the same time, thus allowing the programmer to select the best features of each.

## I/O CAPABILITY

The MC403 has 8 built in 24V inputs and 4 bi-directional I/O channels. These may be used for system interaction or may be defined to be used by the controller for end of travel limits, registration, datuming and feedhold functions if required. The MC403 can have up to 512 external Input and Output channels connected using DIN rail mounted CAN I/O modules. These units connect to the built-in CANbus port.

## COMMUNICATIONS

A 10/100 base-T Ethernet port is fitted as standard and this is the primary communications connection to the MC403. Many protocols are supported including Telnet, Modbus TCP, Ethernet IP and TrioPCMotion. Check the Trio website ([www.triomotion.com](http://www.triomotion.com)) for a complete list.



The MC403 has one built in RS232 port and one built in duplex RS485 channel for simple factory communication systems. Either the RS232 port or the RS485 port may be configured to run the Modbus or Hostlink protocol for PLC or HMI interfacing.

If the built-in CAN channel is not used for connecting I/O modules, it may optionally be used for CAN communications. E.g. DeviceNet, CANopen etc.

### REMOVABLE STORAGE

The MC403 has a micro-SD Card slot which allows a simple means of transferring programs, firmware and data without a PC connection. Offering the OEM easy machine replication and servicing.

The memory slot is compatible with a wide range of micro-SD cards up to 16Gbytes using the FAT32 compatible file system.



### AXIS POSITIONING FUNCTIONS

The motion control software receives instructions to move an axis or axes from the TrioBASIC or IEC 61131-3 language which is running concurrently on the same processor. The motion generation software provides control during operation to ensure smooth, coordinated movements with the velocity profiled as specified by the controlling program. Linear interpolation may be performed on groups of axes, and circular, helical or spherical interpolation in any two/three orthogonal axes. Each axis may run independently or they may be linked in any combination using interpolation, CAM profile or the electronic gearbox facilities.

Consecutive movements may be merged to produce continuous path motion and the user may program the motion using programmable units of measurement (e.g. mm, inches, revs etc.). The module may also be programmed to control only the axis speed. The positioner checks the status of end of travel limit switches which can be used to cancel moves in progress and alter program execution.

## CONNECTIONS TO THE MC403

### ETHERNET PORT CONNECTION

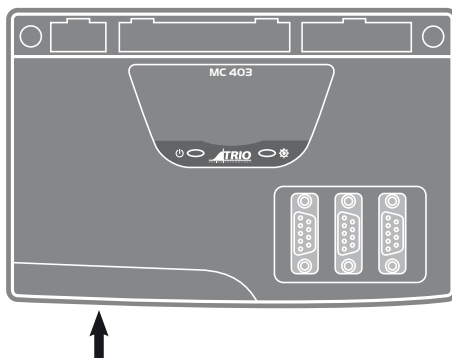

Physical layer: 10/100 base\_T

Connector: RJ45

The Ethernet port is the default connection between the *Motion Coordinator* and the host PC running the *Motion Perfect* development application.

To reset the **IP \_ ADDRESS**, **IP \_ GATEWAY** and **IP \_ NETMASK** to their default values press the IP reset button and power cycle the controller while keeping the button pressed.

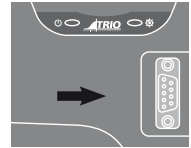

## MC403 SERIAL CONNECTIONS

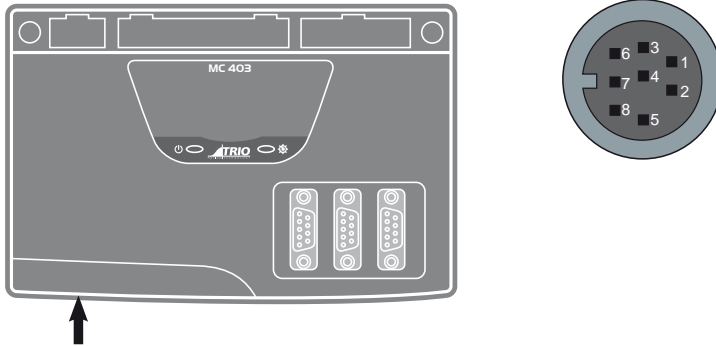

The MC403 features two serial ports. Both ports are accessed through a single 8 pin connector.

### SERIAL CONNECTOR

Pin	Function	Note
1	RS485 Data In A Rx+	Serial Port #2
2	RS485 Data In B Rx-	
3	RS232 Transmit	Serial Port #1
4	0V Serial	
5	RS232 Receive	Serial Port #1
6	Internal 5V	5V supply is limited to 150mA, shared with sync port
7	RS485 Data Out Z Tx-	Serial Port #2
8	RS485 Data Out Y Tx+	Serial Port #2

## MC403 PULSE OUTPUTS / ENCODER INPUTS

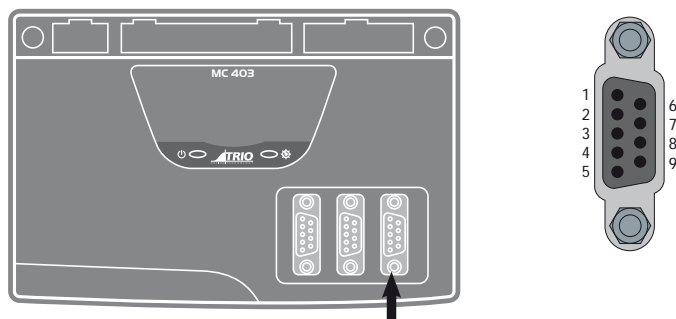

The MC403 is designed to support any combination of servo and pulse input motor drives on the standard controller hardware. The MC403 has 3 versions: 1 axis servo, 2 axis servo and pulse output only. There are also 2 versions of the MC403-Z: 2 axis pulse output and 3 axis pulse output.

Each of the first two axes (0-1) can be enabled as servo(1), pulse and direction or encoder according to the user's requirements by setting the axis **ATYPE** parameter. Axis 2 can be set as either pulse+direction or encoder in all versions.

The function of the 9-pin 'D' connectors will be dependent on the specific axis configuration which has been defined. If the axis is setup as a servo or encoder, the connector will provide the encoder input. If the axis is configured as a pulse+direction, the connector provides differential outputs for step/direction and enable signals.

The encoder port also provides a current-limited 5V output capable of powering most encoders. This simplifies wiring and eliminates external power supplies.

(1) Servo versions of the MC403 only.

Pin	Function	Pulse & Direction	Absolute Encoder **
1	Enc. A	Step+	Clock+
2	Enc. /A	Step-	Clock-
3	Enc. B	Direction+	N/C
4	Enc. /B	Direction-	N/C
5	0V Encoder	0V Pulse+direction	0V Encoder
6	Enc. Z	Enable+	Data+
7	Enc. /Z	Enable-	Data-
8	5V *	5V*	5V*
9	N/C	N/C	N/C

\*5V supply is limited to 150mA (shared with serial port)

\*\*Not available on axes 0 and 1 of the MC403-Z



## REGISTRATION

Each MC403 encoder port has 2 available registration events. These are assigned in a flexible way to any of the 8 digital inputs or can be used with the Z mark input on the encoder port.

## 5-WAY CONNECTOR

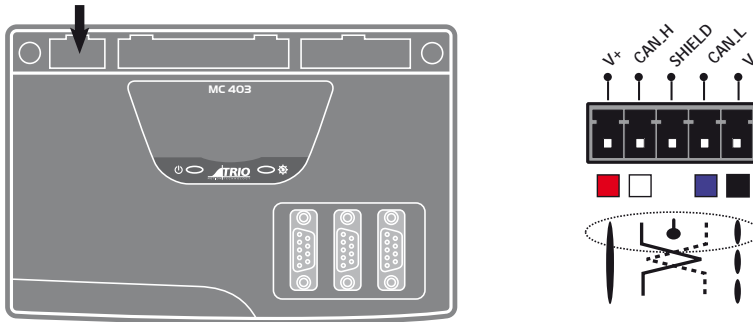

This is a 5 way 3.5 mm pitch connector. The connector is used both to provide the 24 Volt power to the MC403 and provide connections for I/O expansion via Trio’s digital and analogue CAN I/O expanders. 24 Volts must be provided as this powers the unit.

This 24 Volt input is internally isolated from the I/O 24 Volts and the +/-10V Voltage outputs.



24V d.c., Class 2 transformer or power source required for UL compliance. The MC403 is grounded via the metal chassis. It MUST be installed on an unpainted metal plate or DIN rail which is connected to earth. An earth screw is also provided on the rear of the chassis for bonding the MC403 to ground.

## I/O CONNECTOR 1

### 24V INPUT CHANNELS

The MC403 has 8 dedicated 24V Input channels built into the master unit. A further 256 inputs can be provided by the addition of CAN I/O modules. The dedicated input channels are labelled channels 0..7.

Inputs 0 to 7 can be used as registration inputs for axes 0 to 2, using the **REGIST** command.

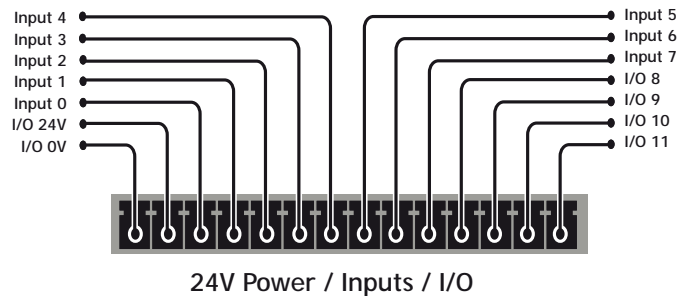

### I/O POWER INPUTS

The I/O 0 Volts (I/O-) and I/O 24 Volts (I/O+) are used to power the 24 Volt digital IO and the analogue I/O, including the servo DAC outputs.

The digital I/O connections are isolated from the module

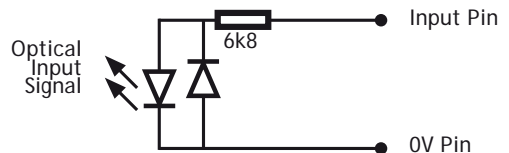

power inputs. The analogue inputs and outputs are isolated from the digital I/O and the module power inputs.

## 24V I/O CHANNELS

Input/output channels 8..11 are bi-directional. The inputs have a protected 24V sourcing output connected to the same pin. If the output is unused it may be used as an input in the program. The input circuitry is the same as on the dedicated inputs. The output circuit has electronic over-current protection and thermal protection which shuts the output down when the current exceeds 250mA.

Care should be taken to ensure that the 250mA limit for each output circuit is not exceeded, and that the total load for the group of 4 outputs does not exceed 1 amp.

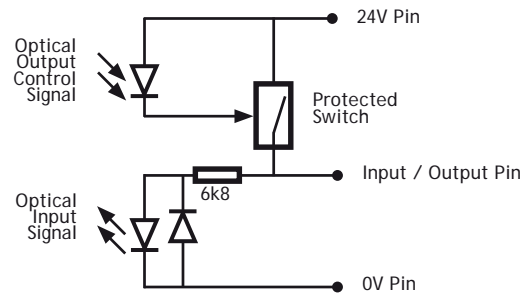

## I/O CONNECTOR 2

### AMPLIFIER ENABLE (WATCHDOG) RELAY OUTPUTS

An internal relay contact is available to enable external amplifiers when the controller has powered up correctly and the system and application software is ready. The amplifier enable is a solid-state relay with an ON resistance of 25Ω at 100mA. The enable relay will be open circuit if there is no power on the controller OR a motion error exists on a servo axis OR the user program sets it open with the **WDOG=OFF** command.

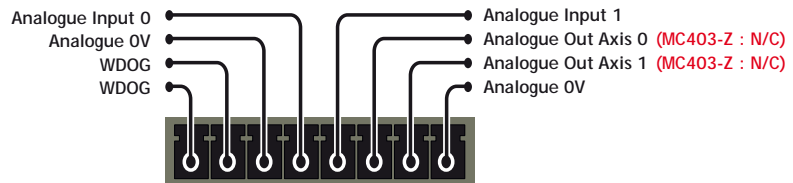

WDOG / Analogue Inputs / Outputs

The amplifier enable relay may, for example, be incorporated within a hold-up circuit or chain that must be intact before a 3-phase power input is made live.



 ALL STEPPER AND SERVO AMPLIFIERS MUST BE INHIBITED WHEN THE AMPLIFIER ENABLE OUTPUT IS OPEN CIRCUIT

## ANALOGUE INPUTS

Two built-in 12 bit analogue inputs are provided which are set up with a scale of 0 to 10V. External connection to these inputs is via the 2-part terminal strip I/O connector 2.

A 24V d.c. supply must be applied to I/O connector 1 to provide power for the analogue input circuit.

## ANALOGUE OUTPUTS

The MC403 has 2 12-bit analogue outputs scaled at +/-10V. Each output is assigned to one servo axis, or in the case where the axis is not used, or is set as a pulse+direction/simulated encoder output, the analogue output may be set to a voltage directly in software.

A 24V d.c. supply must be applied to I/O connector 1 to provide power for the analogue output circuit.







The MC403-Z does not have any analogue outputs.

## LED DISPLAY

On power-up, the LEDs flash to show the MC403 version and the SD card status.

P821 2 axis pulse output MC403-Z:	3 flashes of the RED LED.
P822 3 axis pulse output MC403-Z	3 flashes of both LEDs alternately.
P823 3 axis pulse output version:	3 flashes of the RED LED.
P824 2 axis servo version:	3 flashes of both LEDs alternately.
P825 1 axis servo version:	3 flashes of the GREEN LED.
SD card loading system software:	Both LEDs flash together until the system SW load is completed.

During operation, the two LED's show the processor (OK) and system status.

Display at start-up	Display with WDOG on	Display Error
 	 	 
green - ON red - ON	green - ON red - OFF	green - ON red - FLASHING

**MC403 FEATURE SUMMARY**

Size	122 mm x 135 mm x 35 mm (HxWxD).
Weight	325g
Operating Temp.	0 - 45 degrees C.
Control Inputs	Forward Limit, Reverse Limit, Datum Input, Feedhold Input.
Communication Ports	RS232 channel: up to 128k baud. RS485 channel: up to 128k baud. CANbus port (DeviceNet and CANopen compatible). Ethernet: 10/100 BaseT multiple port connection.
Position Resolution	64 bit position count.
Speed Resolution	32 bits. Speed may be changed at any time. Moves may be merged.
Servo Cycle	125µs minimum, 1ms default, 2ms max.
Programming	Multi-tasking TrioBASIC system and IEC 61131-3 programming system. Maximum 6 user processes.
Interpolation modes	Linear 1-3 axes, circular, helical, spherical, CAM Profiles, speed control, electronic gearboxes.
Memory	8 Mbyte user memory. 512,000 x 64 bit TABLE memory. Automatic flash EPROM program and data storage.
VR	4096 global VR data in FLASH memory (automatic-store).
SD Card	Standard micro-SD Card compatible to 16Gbytes. Used for storing programs and/or data.
Power Input	24V d.c., Class 2 transformer or power source. 18..29V d.c. at 300mA + IO supply.
Amplifier Enable Output	Normally open solid-state relay rated 24V ac/dc nominal. Max load 100mA. Max Voltage 29V.
Analogue Inputs	2 isolated, 12 bit, 0 to 10V.
Serial / Encoder Power Output	5V at 150mA. (Max)
Analogue Outputs	2 isolated 12 bit, +/- 10V (MC403 only)
Digital Inputs	8 Opto-isolated 24V inputs.
Digital I/O	4 Opto-isolated 24V outputs. Current sourcing (PNP) 250 mA. (max. 1A per bank of 4).
Product Codes	P821 : MC403-Z 2 axis stepper output / 2 encoder input P822 : MC403-Z 3 axis stepper output / 3 encoder input P823 : MC403 3 axis stepper output / 3 encoder input P824 : MC403 2 axis servo + 1 encoder / 3 axis stepper P825 : MC403 1 axis servo + 1 encoder / 2 axis stepper

**MC403 AXIS CONFIGURATION SUMMARY**

CONFIGURATION	P823	P824	P825	P821	P822
Axis 0	Core	Extended+AS	Extended+AS	Core	Core
Axis 1	Core	Extended+AS		Core	Core
Axis 2	Core	Extended	Core		Extended
<b>AXES</b>					
# of axes (max)	3	3	2	2	3
# of virtual axes (max)	16	16	16	16	16
<b>DRIVE INTERFACES</b>					
Stepper (Step & Direction)	Yes	Yes	Yes	Yes	Yes
Servo ( $\pm 10V$ & Encoder)	No	Yes	Yes	No	No
<b>ENCODER PORTS</b>					
Feedback input	No	Yes	Yes (1 axis)	No	No
Reference input	Yes	Yes	Yes	Yes	Yes
Pulse + direction output	Yes	Yes	Yes	Yes	Yes
Incremental (A+B) output	Yes	Yes	Yes	Yes	Yes
<b>BUILT-IN I/O</b>					
Inputs 24Vdc	8	8	8	8	8
Bi-directional I/O 24Vdc	4	4	4	4	4
0-10V analogue inputs	2x12bit	2x12bit	2x12bit	2x12bit	2x12bit
$\pm 10V$ analogue Outputs	2x12bit	2x12bit	2x12bit	No	No
# registration inputs	6	6	6	6	6
Registration input speed	20 $\mu$ s	20 $\mu$ s	20 $\mu$ s	20 $\mu$ s	20 $\mu$ s

**CONFIGURATION KEY****CORE FUNCTIONALITY**

CORE AXES - can be configured in software as pulse and direction outputs with stepper or servo drives. They can also be configured for incremental encoder feedback.

Core functionality is a set of ATYPES (Axis TYPES) that are available on all controllers. They are based on pulse outputs and incremental encoder feedback.

ATYPE	Description
43	Pulse and direction output with enable output
45	Quadrature encoder output with enable output
63	Pulse and direction output with Z input
64	Quadrature encoder output with Z input

- 76 Incremental encoder with Z input
- 78 Pulse and direction with **VFF** \_ **GAIN** and enable output 1

### EXTENDED FUNCTIONALITY

**EXTENDED AXES** - in addition to the Core functionality these axes can also be configured for absolute encoders and closed loop servos (requires voltage output).

**ANALOGUE SERVO** - Only axes marked as **AS** have an analogue output and can be used for closed loop control.

All Extended Axes can use these **ATYPE**'s as feedback.

If you want to just use the feedback and not complete a closed loop servo system set **SERVO** = OFF

ATYPE	Description
30	Analogue feedback Servo
44	Incremental encoder Servo with Z input
46	Tamagawa absolute Servo
47	Endat absolute Servo
48	SSI absolute Servo
60	Pulse and direction feedback Servo with Z input
77	Incremental encoder Servo with enable output

# Motion Coordinator MC405

## OVERVIEW

The *Motion Coordinator MC405* is based on Trio's high-performance ARM11 double-precision technology and provides 4 axes of servo plus a master encoder axis, or 5 axes of pulse+direction control for stepper drives or pulse-input servo drives. Trio uses advanced FPGA techniques to reduce the size and fit the pulse output and servo circuitry in a compact DIN-rail mounted package. The MC405 is housed in a rugged plastic case with integrated earth chassis and incorporates all the isolation circuitry necessary for direct connection to external equipment in an industrial environment. Filtered power supplies are included so that it can be powered from the 24V d.c. logic supply present in most industrial cabinets.

It is designed to be configured and programmed for the application using a PC running Trio's *Motion Perfect* application software, and then may be set to run "standalone" if an external computer is not required for the final system. Programs and data are stored directly to FLASH memory, thus eliminating the need for battery backed storage.

The Multi-tasking version of TrioBASIC for the MC405 allows up to 10 TrioBASIC programs to be run simultaneously on the controller using pre-emptive multi-tasking. In addition, the operating system software includes a the IEC 61131-3 standard run-time environment (licence key required).



## PROGRAMMING

The Multi-tasking ability of the MC405 allows parts of a complex application to be developed, tested and run independently, although the tasks can share data and motion control hardware. The 10 available tasks can be used for TrioBASIC or IEC 61131-3 programs, or a combination of both can be run at the same time, thus allowing the programmer to select the best features of each.

## I/O CAPABILITY

The MC405 has 8 built in 24V inputs and 8 bi-directional I/O channels. These may be used for system interaction or may be defined to be used by the controller for end of travel limits, registration, datuming and feedhold functions if required. Each of the Input/Output channels has a status indicator to make it easy to check them at a glance. The MC405 can have up to 512 external Input and Output channels connected using DIN rail mounted CAN I/O modules. These units connect to the built-in CANbus port.

## COMMUNICATIONS

A 10/100 base-T Ethernet port is fitted as standard and this is the primary communications connection to the MC405. Many protocols are supported including Telnet, Modbus TCP, Ethernet IP and TrioPCMotion. Check the Trio website ([www.triomotion.com](http://www.triomotion.com)) for a complete list.

The MC405 has one built in RS232 port and one built in duplex RS485 channel for simple factory

communication systems. Either the RS232 port or the RS485 port may be configured to run the Modbus or Hostlink protocol for PLC or HMI interfacing.

If the built-in CAN channel is not used for connecting I/O modules, it may optionally be used for CAN communications. E.g. DeviceNet, CANopen etc.

### REMOVABLE STORAGE

The MC405 has a micro-SD Card slot which allows a simple means of transferring programs, firmware and data without a PC connection. Offering the OEM easy machine replication and servicing.

The memory slot is compatible with a wide range of micro-SD cards up to 2Gbytes using the FAT32 compatible file system.



### AXIS POSITIONING FUNCTIONS

The motion control generation software receives instructions to move an axis or axes from the TrioBASIC or IEC 61131-3 language which is running concurrently on the same processor. The motion generation software provides control during operation to ensure smooth, coordinated movements with the velocity profiled as specified by the controlling program. Linear interpolation may be performed on groups of axes, and circular, helical or spherical interpolation in any two/three orthogonal axes. Each axis may run independently or they may be linked in any combination using interpolation, CAM profile or the electronic gearbox facilities.

Consecutive movements may be merged to produce continuous path motion and the user may program the motion using programmable units of measurement (e.g. mm, inches, revs etc.). The module may also be programmed to control only the axis speed. The positioner checks the status of end of travel limit switches which can be used to cancel moves in progress and alter program execution.

### CONNECTIONS TO THE MC405

#### ETHERNET PORT CONNECTION

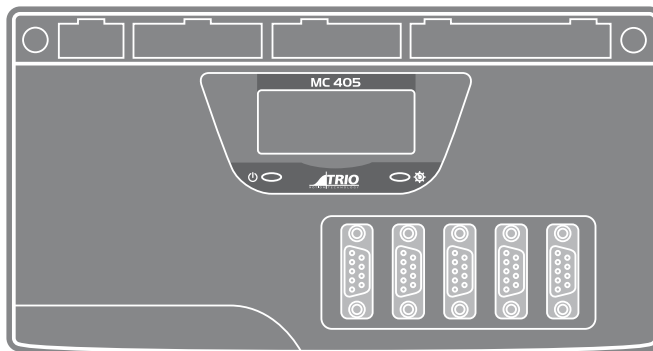

Physical layer: 10/100 base\_T



**CONNECTOR: RJ45**

The Ethernet port is the default connection between the *Motion Coordinator* and the host PC running the *Motion Perfect* development application.

**MC405 SERIAL CONNECTIONS**

The MC405 features two serial ports. Both ports are accessed through a single 8 pin connector.

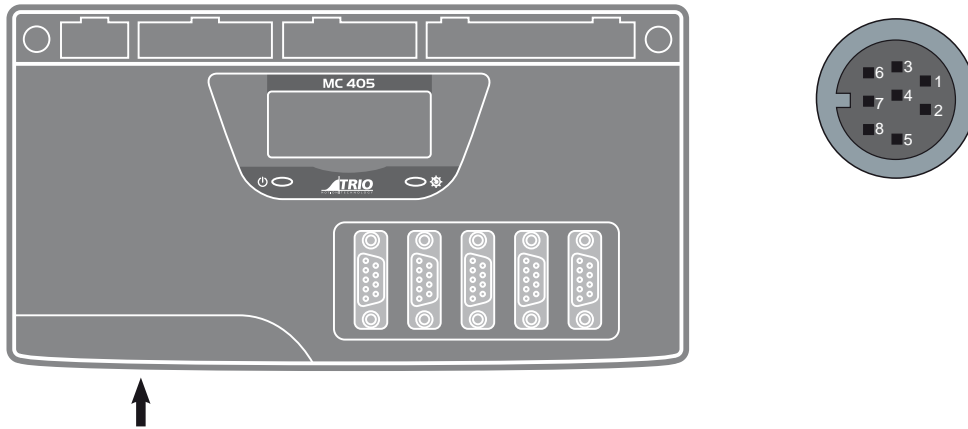
**SERIAL CONNECTOR**

Pin	Function	Note
1	RS485 Data In A Rx+	Serial Port #2
2	RS485 Data In B Rx-	
3	RS232 Transmit	Serial Port #1
4	0V Serial	
5	RS232 Receive	Serial Port #1
6	Internal 5V	5V supply is limited to 150mA, shared with encoder ports
7	RS485 Data Out Z Tx-	Serial Port #2
8	RS485 Data Out Y Tx+	Serial Port #2

## MC405 PULSE+DIRECTION OUTPUTS / ENCODER INPUTS

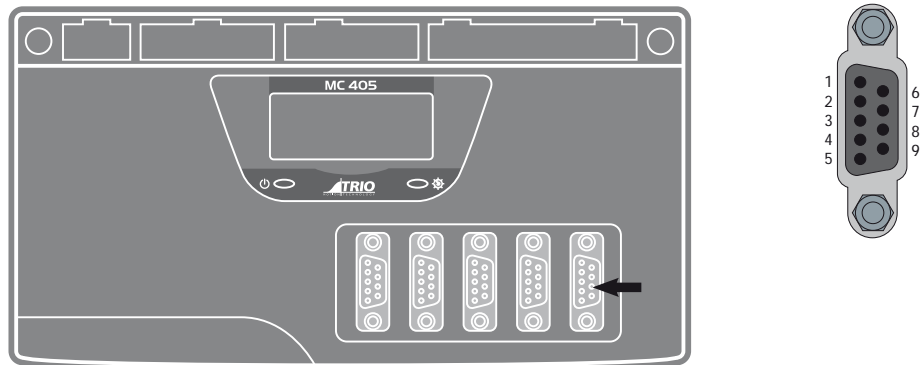

The MC405 is designed to support any combination of servo and pulse driven motor drives on the standard controller hardware. There are 2 versions of the MC405; the servo version and the pulse output only version. In the pulse output only version, only axis 4 can be configured as an encoder input.

Each of the first four axes (0-3) can be enabled as servo(1), pulse output or encoder(1) according to the user's requirements by setting the axis **ATYPE** parameter. Axis 4 can be set as either pulse output, encoder output or encoder input on all versions.

The function of the 9-pin 'D' connectors will be dependent on the specific axis configuration which has been defined. If the axis is setup as a servo, the connector will provide the encoder input(1). If the axis is configured as a pulse output, the connector provides differential outputs for step/direction or simulated encoder, and enable signals.

The encoder port also provides a current-limited 5V output capable of powering most encoders. This simplifies wiring and eliminates external power supplies.

(1) Servo version of the MC405 only.

Pin	Encoder in/out	Pulse + Direction	Absolute Encoder
1	Enc. A	Step+	Clock+
2	Enc. /A	Step-	Clock-
3	Enc. B	Direction+	N/C
4	Enc. /B	Direction-	N/C
5	0V Encoder	0V Pulse+direction	0V Encoder
6	Enc. Z	Enable+	Data+
7	Enc. /Z	Enable-	Data-
8	5V *	5V*	5V*
9	N/C	N/C	N/C

\*5V supply is limited to 150mA (shared with serial port)

## REGISTRATION

Each MC405 encoder port has 2 available registration events. These are assigned in a flexible way to any of the 8 digital inputs or can be used with the Z mark input on the encoder port.

## 5-WAY CONNECTOR

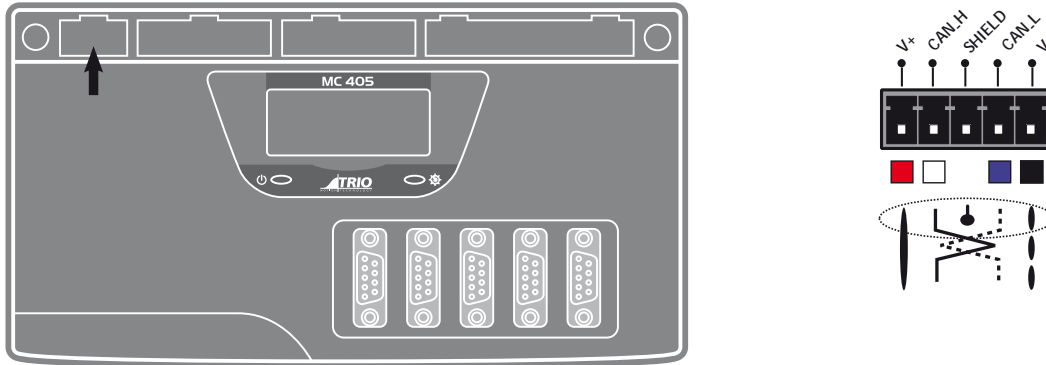

This is a 5 way 3.5 mm pitch connector. The connector is used both to provide the 24 Volt power to the MC405 and provide connections for I/O expansion via Trio’s digital and analogue CAN I/O expanders. 24 Volts must be provided as this powers the unit.

This 24 Volt input is internally isolated from the I/O 24 Volts and the +/-10V voltage outputs.

24V d.c., Class 2 transformer or power source required for UL compliance. The MC405 is grounded via the metal chassis. It **MUST** be installed on an unpainted metal plate or DIN rail which is connected to earth. An earth screw is also provided on the rear of the chassis for bonding the MC405 to ground.

## I/O CONNECTOR 1

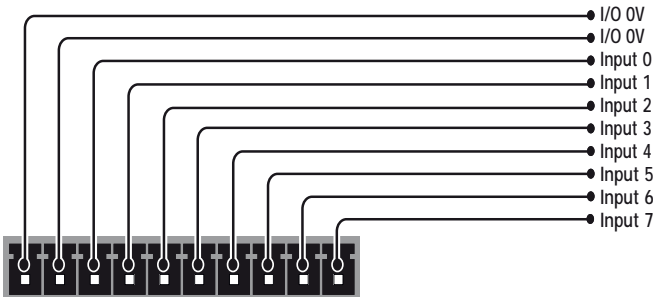

## I/O CONNECTOR 2

### 24V INPUT CHANNELS

The MC405 has 8 dedicated 24V Input channels built into the master unit. A further 256 inputs can be provided by the addition of CAN I/O modules. The dedicated input channels are labelled channels 0..7. Two terminals marked IN- are provided for the input 0V common connections.

Inputs 0 to 7 can be used as registration inputs for axes 0 to 4, using the **REGIST** command.

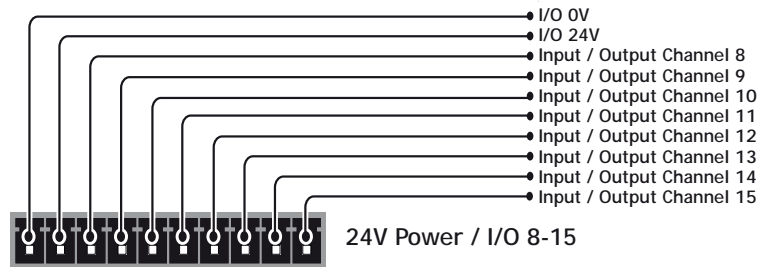

### I/O POWER INPUTS

The I/O 0 Volts (I/O-) and I/O 24 Volts (I/O+) are used to power the 24 Volt digital IO and the analogue I/O, including the servo DAC outputs.

The digital I/O connections are isolated from the module power inputs. The analogue inputs and outputs are isolated from the digital I/O and the module power inputs.

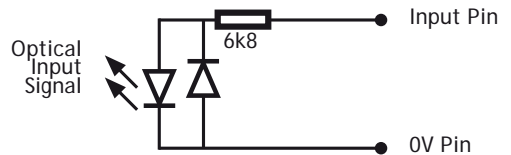

### 24V I/O CHANNELS

Input/output channels 8..15 are bi-directional. The inputs have a protected 24V sourcing output connected to the same pin. If the output is unused it may be used as an input in the program. The input circuitry is the same as on the dedicated inputs. The output circuit has electronic over-current protection and thermal protection which shuts the output down when the current exceeds 250mA.

Care should be taken to ensure that the 250mA limit for each output circuit is not exceeded, and that the total load for the group of 8 outputs does not exceed 1 amp.

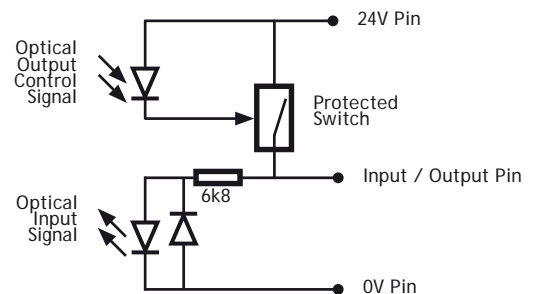

### I/O CONNECTOR 3

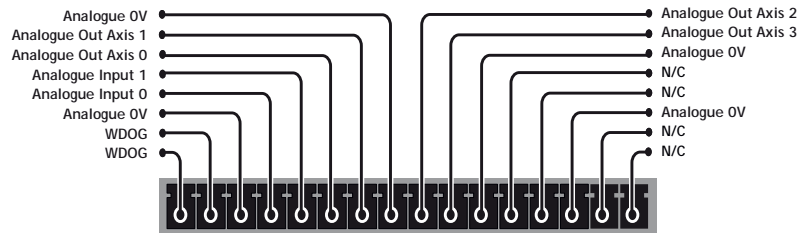

WDOG / Analogue Inputs / Analogue Outputs

### AMPLIFIER ENABLE (WATCHDOG) RELAY OUTPUTS

An internal relay contact is available to enable external amplifiers when the controller has powered up correctly and the system and application software is ready. The amplifier enable is a solid-state relay with an ON resistance of 25Ω at 100mA. The enable relay will be open circuit if there is no power on the controller OR a motion error exists on a servo axis OR the user program sets it open with the **WDOG=OFF** command.

The amplifier enable relay may, for example, be incorporated within a hold-up circuit or chain that must be intact before a 3-phase power input is made live.

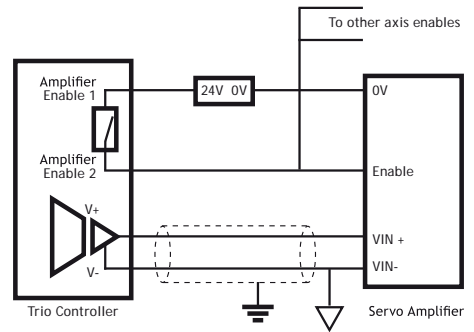

**ALL STEPPER AND SERVO AMPLIFIERS MUST BE INHIBITED WHEN THE AMPLIFIER ENABLE OUTPUT IS OPEN CIRCUIT**

### ANALOGUE INPUTS

Two built-in 12 bit analogue inputs are provided which are set up with a scale of 0 to 10V. External connection to these inputs is via the 2-part terminal strip I/O connector 3.

A 24V d.c. supply must be applied to I/O connector 2 to provide power for the analogue input circuit.

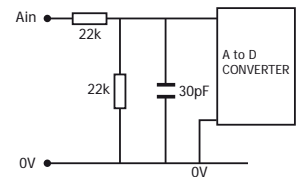

### ANALOGUE OUTPUTS

The MC405 has 4 12-bit analogue outputs scaled at +/-10V. Each output is assigned to one servo axis, or in the case where the axis is not used, or is set as a pulse+direction/simulated encoder output, the analogue output may be set to a voltage directly in software.

A 24V d.c. supply must be applied to I/O connector 2 to provide power for the analogue output circuit.

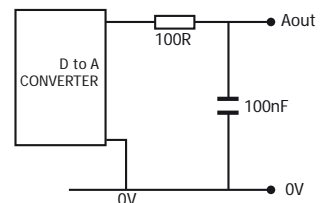

## BACKLIT DISPLAY

On power-up, the information display area shows bt during the boot process, then the MC405 version is displayed, showing P826 for the 5 axis pulse output version and P827 for the 4 axis servo version. The IP address and subnet mask is shown on power-up and whenever an Ethernet cable is first connected to the MC405.

During operation, this display shows run, Off or Err to indicate the MC405 status. Below the main status display are the **ERROR** and **ENABLE** indicators.

**ERROR:** An error has occurred (see Error Display Codes table below for details).

**ENABLE:** When illuminated, WDOG is ON.

A bank of 8 indicators at the left side shows the Digital Input States and a similar bank on the right shows the state of I/O8 to I/O15. The I/O displayed can be altered using the **DISPLAY** command.

Two LED's are provided to show the processor (OK) and system status.



### Error Display Codes

Ann	Axis error on axis nn	
Caa	Configuration error on unit aa	ie: too many axes
Exx	System error	E00 - RAM error 8bit BB - RAM (VR) E01 - RAM error 16 bit BB - RAM (TABLE) E03 - Battery Error E04 - VR/TABLE corrupt entry E05 - Invalid MC_CONFIG file E06 - Started in SAFE mode

**MC405 FEATURE SUMMARY**

Size	122 mm x 186 mm x 35 mm (HxWxD).
Weight	476g
Operating Temp.	0 - 45 degrees C.
Control Inputs	Forward Limit, Reverse Limit, Datum Input, Feedhold Input.
Communication Ports	RS232 channel: up to 128k baud. RS485 channel: up to 128k baud. CANbus port (DeviceNet and CANopen compatible) Ethernet: 10/100 BaseT multiple port connection.
Position Resolution	64 bit position count.
Speed Resolution	32 bits. Speed may be changed at any time. Moves may be merged.
Servo Cycle	125µs minimum, 1ms default, 2ms max.
Programming	Multi-tasking TrioBASIC system and IEC 61131-3 programming system. Maximum 10 user processes.
Interpolation modes	Linear 1-5 axes, circular, helical, spherical, CAM Profiles, speed control, electronic gearboxes.
Memory	8 Mbyte user memory. 512,000 x 64 bit TABLE memory. Automatic flash EPROM program and data storage.
Real Time Clock	Capacitor backed for 10 days or power off.
VR	4096 global VR data in FLASH memory. (automatic-store)
SD Card	Standard micro-SD Card compatible to 2Gbytes. Used for storing programs and/or data.
Power Input	24V d.c., Class 2 transformer or power source. 18..29V d.c. at 350mA + IO supply.
Amplifier Enable Output	Normally open solid-state relay rated 24V ac/dc nominal. Maximum load 100mA. Maximum Voltage 29V.
Analogue Inputs	2 isolated, 12 bit, 0 to 10V.
Serial / Encoder Power Output	5V at 150mA.
Digital Inputs	8 Opto-isolated 24V inputs.
Digital I/O	8 Opto-isolated 24V outputs. Current sourcing (PNP) 250 mA. (max. 1A per bank of 8).
Product Code	P826 : MC405, 5 axis stepper P827 : MC405, 4 axis servo / 5 axis stepper

# Motion Coordinator Euro404 /408

## OVERVIEW

The *Motion Coordinator Euro404* and *Euro408* are Eurocard stepper/servo positioners with the built-in ability to control up to 8 servo or stepper motors in any combination. The Euro404 / 408 is designed to provide a powerful yet cost-effective control solution for OEM machine builders who are prepared to mount the unit and provide the power supplies required. It is designed to be configured and programmed for the application with TrioBASIC or IEC61131-3 standard languages using a PC. It may then may be set to run “standalone” if an external computer is not required for the final system. The Multi-tasking version of TrioBASIC for the Euro404 / 408 allows up to 10 TrioBASIC programs to be run simultaneously on the controller using preemptive multi-tasking.

## PROGRAMMING

The Multi-tasking ability of the Euro404 / 408 allows parts of a complex application to be developed, tested and run independently, although the tasks can share data and motion control hardware.

## I/O CAPABILITY

The Euro404 / 408 has 16 built in 24V inputs and 8 built-in output channels. These may be used for system interaction or may be defined to be used by the controller for end of travel limits, datuming and feedhold functions if required. 8 status LEDs are available which can be set to display the status of banks of inputs or outputs. The Euro404 / 408 can have up to 512 external Input/Output channels, up to 32 analogue input channels and up to 16 analogue output channels connected using DIN rail mounted I/O modules. These units connect to the built-in CAN channel of the Euro404 / 408.

## COMMUNICATIONS

The Euro404 / 408 has one Ethernet port for primary communications, one RS-232 port and one RS-485 built in.

The Ethernet port, RS-232 port or the RS485 port may be configured to run the MODBUS protocol for PLC or HMI interfacing. If the built-in CAN channel is not used for connecting I/O modules, it may optionally be used for CAN communications or DeviceNet.

## REMOVABLE STORAGE

A micro SD card can be used with the Euro404 / 408 allows a simple means of transferring programs without a PC connection. Offering the OEM easy machine replication and servicing. The Euro404 / 408 supports SD cards up to 16Gbytes. Each Micro SD Card must be pre-formatted using a PC to FAT32 before it can be used in the SD Card Adaptor.

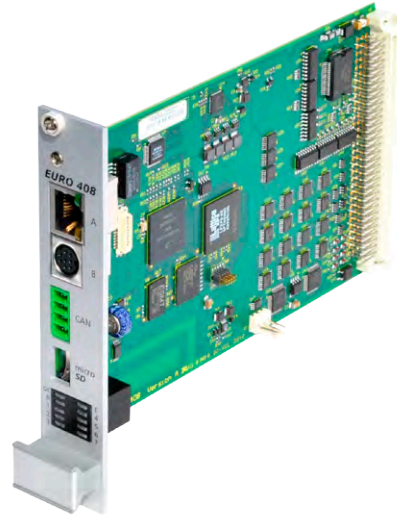



## AXIS CONFIGURATION

The Euro404 / 408 is available in 2 configurations. Either as an 8 axis pulse output card or as the full axis servo card.

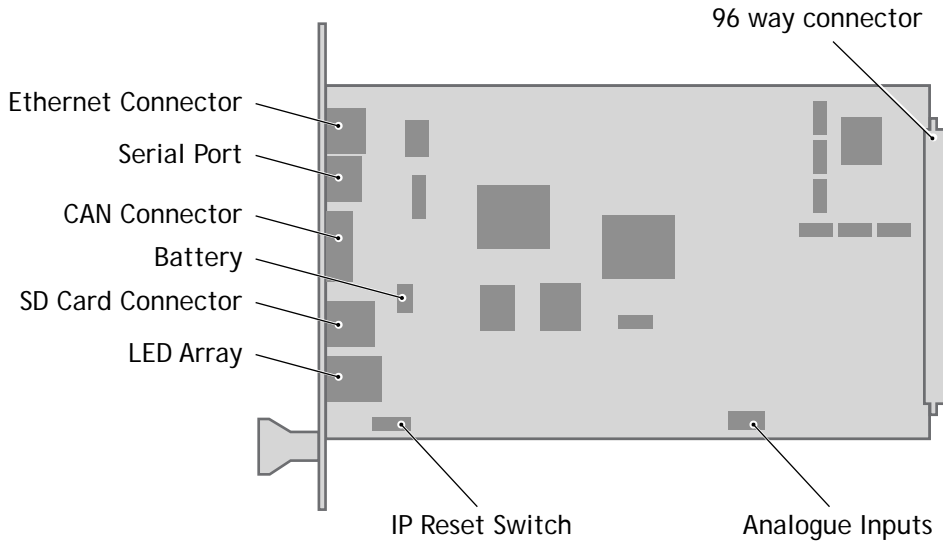

### Connections to the Euro404 / 408

## 5 VOLT POWER SUPPLY

The minimum connections to the Euro404 / 408 are just the 0V and 5V pins. The Euro404 / 408 is protected against reverse polarity on these pins. Application of more than 5.25 Volts will permanently damage the *Motion Coordinator* beyond economic repair. All the 0V are internally connected together and all the 5v pins are internally connected together. The 0V pins are, in addition, internally connected to the AGND pins. The Euro404 / 408 has a current consumption of approximately 500mA on the 5V supply. The supply should be filtered and regulated within 5%.

## BUILT-IN CAN CONNECTOR

The Euro404 / 408 features a built-in CAN channel. This is primarily intended for Input/ Output expansion via Trio's CAN I/O modules. It may be used for other purposes when I/O expansion is not required.

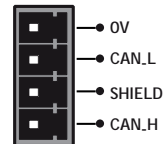

## EURO404 / 408 BACKPLANE CONNECTOR

Most connections to the Euro404 / 408 are made via the 96 Way DIN41612 backplane Connector.

Euro408	C	B	A
1	5V	5V	5V
2	5V	5V	5V
3	0V	0V	0V
4	IO GND	OP13	OP10
5	OP9	OP12	OP15
6	OP8	OP11	OP14
7	IO 24V	IN0 / R0	IN1 / R1
8	IN2 / R2	IN3 / R3	IN4 / R4
9	IN5 / R5	IN6 / R6	IN7 / R7
10	IN8	IN9	IN10
11	IN11	IN12	N13
12	IN14	0V	IN15
13	A7- / STEP7-	B7- / DIR7-	Z7- / ENABLE7-
14	A7+ / STEP7+	B7+ / DIR7+	Z7+ / ENABLE7+
15	A6- / STEP6-	B6- / DIR6-	Z6- / ENABLE6-
16	A6+ / STEP6+	B6+ / DIR6+	Z6+ / ENABLE6+
17	A5- / STEP5-	B5- / DIR5-	Z5- / ENABLE5-
18	A5+ / STEP5+	B5+ / DIR5+	Z5+ / ENABLE5+
19	A4- / STEP4-	B4- / DIR4-	Z4- / ENABLE4-
20	A4+ / STEP4+	B4+ / DIR4+	Z4+ / ENABLE4+
21	A3- / STEP3-	B3- / DIR3-	Z3- / ENABLE3-
22	A3+ / STEP3+	B3+ / DIR3+	Z3+ / ENABLE3+
23	A2- / STEP2-	B2- / DIR2-	Z2- / ENABLE2-
24	A2+ / STEP2+	B2+ / DIR2+	Z2+ / ENABLE2+
25	A1- / STEP1-	B1- / DIR1-	Z1- / ENABLE1-
26	A1+ / STEP1+	B1+ / DIR1+	Z1+ / ENABLE1+
27	A0- / STEP0-	B0- / DIR-	Z0- / ENABLE0-
28	A0+ / STEP0+	B0+ / DIR+	Z0+ / ENABLE0+
29	VOUT7	VOUT6	VOUT5
30	AGND	VOUT4	VOUT3
31	VOUT2	VOUT1	VOUT0
32	ENABLE1	ENABLE2	Earth

Euro404	C	B	A
1	5V	5V	5V
2	5V	5V	5V
3	0V	0V	0V
4	IO GND	OP13	OP10
5	OP9	OP12	OP15
6	OP8	OP11	OP14
7	IO 24V	IN0 / R0	IN1 / R1
8	IN2 / R2	IN3 / R3	IN4 / R4
9	IN5 / R5	IN6 / R6	IN7 / R7
10	IN8	IN9	IN10
11	IN11	IN12	N13
12	IN14	0V	IN15
13	N/C	N/C	N/C
14	N/C	N/C	N/C
15	N/C	N/C	N/C
16	N/C	N/C	N/C
17	N/C	N/C	N/C
18	N/C	N/C	N/C
19	N/C	N/C	N/C
20	N/C	N/C	N/C
21	A3- / STEP3-	B3- / DIR3-	Z3- / ENABLE3-
22	A3+ / STEP3+	B3+ / DIR3+	Z3+ / ENABLE3+
23	A2- / STEP2-	B2- / DIR2-	Z2- / ENABLE2-
24	A2+ / STEP2+	B2+ / DIR2+	Z2+ / ENABLE2+
25	A1- / STEP1-	B1- / DIR1-	Z1- / ENABLE1-
26	A1+ / STEP1+	B1+ / DIR1+	Z1+ / ENABLE1+
27	A0- / STEP0-	B0- / DIR-	Z0- / ENABLE0-
28	A0+ / STEP0+	B0+ / DIR+	Z0+ / ENABLE0+
29	N/C	N/C	N/C
30	AGND	N/C	VOUT3
31	VOUT2	VOUT1	VOUT0
32	ENABLE1	ENABLE2	Earth

## AMPLIFIER ENABLE (WATCHDOG) RELAY OUTPUT

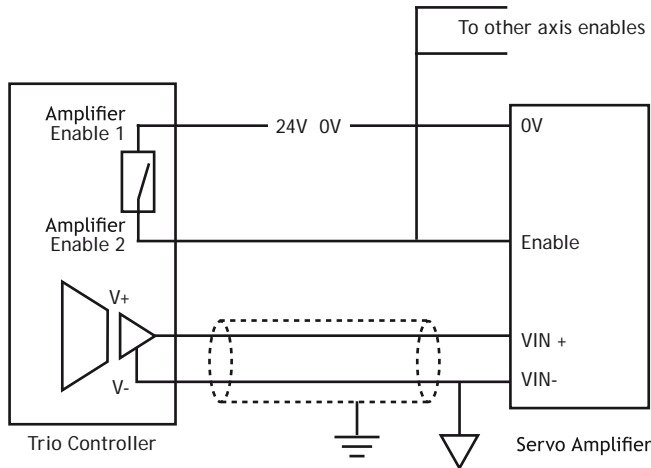

An internal relay contact is used to enable external amplifiers when the controller has powered up correctly and the system and application software is ready. The amplifier enable is a solid-state relay on the Euro404 / 408 with normally open “contacts”. The enable relay will be open circuit if there is no power on the controller OR a following error exists on a servo axis OR the user program sets it open with the **wDOG=OFF** command. The amplifier enable relay may, for example, be incorporated within a hold-up circuit or chain that must be intact before a 3-phase power input is made live.



Note: all stepper and servo amplifiers **MUST** be inhibited when the amplifier enable output is open circuit

## 24V INPUT CHANNELS

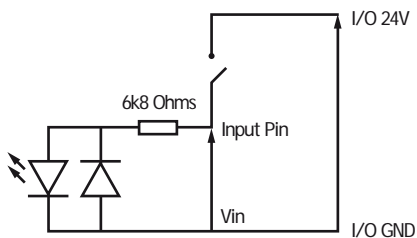

The *Motion Coordinator* has 16 24V Input channels built into the master unit. These may be expanded to 256 Inputs by the addition of CAN-16 I/O modules.

## 24V OUTPUT CHANNELS

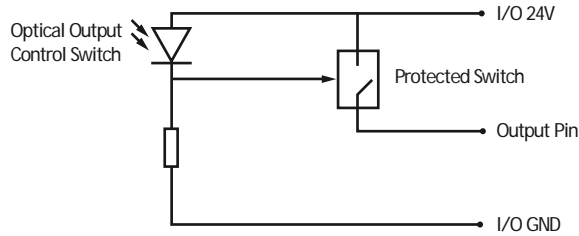

8 output channels are provided. These channels are labelled 8..15 for compatibility with other *Motion Coordinators*, but are NOT bi-directional as on some *Motion Coordinators*. Each channel has a protected 24v sourcing output. The output circuit has electronic over-current protection and thermal protection which shuts the output down when the current exceeds 250mA. Care should still be taken to ensure that the 250mA limit for the output circuit is not exceeded, and that the total load for the group of 8 outputs does not exceed 1 amp. Up to 256 further Outputs may be added by the addition of CAN-16I/O modules).

## REGISTRATION INPUTS

The registration inputs are 24 Volt isolated inputs that are shared with digital inputs 0 to 7. The Euro404 / 408 can be programmed to capture the position of an encoder axis in hardware when a transition occurs on the registration input.

## DIFFERENTIAL ENCODER INPUTS

The encoder inputs on the Euro404 / 408 are designed to be directly connected to 5 Volt differential output encoders. Incremental or absolute encoders can be connected to the ports.

The encoder ports are also bi-directional so that when axes are set to pulse and direction, the encoder port for that axis becomes a Differential output.

Encoder ports and pulse direction ports on the Euro404 / 408 are NOT electrically isolated.

## VOLTAGE OUTPUTS

The Euro404 can generate up to 4 +/-10Volt analogue outputs and the Euro408 can generate up to 8 +/-10Volt analogue outputs for controlling servo-amplifiers. Note that for servo operation the card must be configured as a 4 or 8 axis servo. However, the voltage outputs can be used separately via the DAC command in TrioBASIC even when the servo axis is not enabled.

## ANALOGUE INPUTS

Two built-in 12 bit analogue inputs are provided which are set up with a scale of 0 to 10 Volts. In order to make connection to these inputs, there is a 2 part molex connector behind the front panel. Pin 1 is nearest the front panel.

Pin 1	AIN(32)	Mating MOLEX connector part number
Pin 2	AIN(33)	Connector housing: 22-01-2035
Pin 3	0V	Crimp receptacles : 08-50-0032 (3 required)

## USING END OF TRAVEL LIMIT SENSORS

Each axis of the *Motion Coordinator* system may have a 24v Input channel allocated to it for the functions:

<b>FORWARD Limit</b>	Forward end of travel limit
<b>REVERSE Limit</b>	Reverse end of travel limit
<b>DATUM Input</b>	Used in datuming sequence
<b>FEEDHOLD Input</b>	Used to suspend velocity profiled movements until the input is released

Switches used for the **FORWARD/REVERSE/DATUM/FEEDHOLD** inputs may be normally closed or normally open but the **NORMALLY CLOSED** type is recommended.

Each of the functions is optional and may be left unused if not required. Each of the 4 functions are available for each axis and can be assigned to any input channel including remote CAN I/O. An input can be assigned to more than one function if desired.

The axis parameters: **FWD \_ IN, REV \_ IN, DATUM \_ IN** and **FH \_ IN** are used to assign input channels to the functions. The axis parameters are set to -1 if the function is not required.

## ETHERNET PORT CONNECTION

Physical layer: 10/100 baseT

Connector: RJ-45

Connection and activity LED indicators

Fixed IP address

User settable subnet mask and default gateway

**DHCP** client: Not available (fixed IP only)

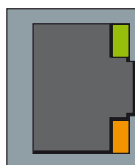

A switch is provided on the board to reset the IP address to a known value. To reset to the default value of 192.168.000.250, slide the switch to the left (RST\_IP) and power up the Euro404 / 408. Make connection with the Euro404 / 408 using *Motion Perfect* on the default address and use the **IP \_ ADDRESS** command to set the required address. e.g. for 192.168.000.123 set **IP \_ ADDRESS=192.168.0.123**.

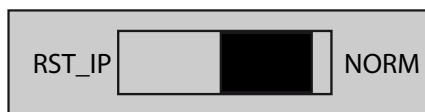

NOTE: The switch also sets the following:

subnet mask to 255.255.255.0

default gateway to 192.168.0.255

Once the IP address has been set, slide switch 1 to NORM and power down the Eurocard. Next time the Euro404 / 408 is powered up, the new IP address can be used.

**SERIAL CONNECTOR B:**

Euro404 / 408 Serial Port Connections

Pin	Function	Note
1	RS485 Data In A Rx+	Serial Port #2
2	RS485 Data In B Rx-	
3	RS232 Transmit	Serial Port #1
4	Serial 0V	
5	RS232 Receive	Serial Port #2
6	5V OUT	
7	RS485 Data Out Z Tx-	
8	RS485 Data Out Y Tx+	

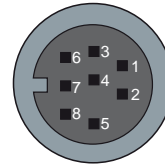

**EURO404 / 408 - FEATURE SUMMARY**

Size	170 mm x 129 mm Overall (160mm x 100 mm PCB) 25mm deep
Weight	160 g
Operating Temp.	0 - 45 degrees C
Control Inputs	Forward Limit, Reverse Limit, Datum Input, Feedhold Input.
Communication Ports	RS232 channel: up to 128k baud. RS485 channel: up to 128k baud. CANbus port (DeviceNet and CANopen compatible) Ethernet: 10/100 BaseT multiple port connection.
Position Resolution	64 bit position count
Speed Resolution	32 bits. Speed may be changed at any time. Moves may be merged.
Interpolation modes	Linear 1-8 axes, circular, helical, CAM Profiles, speed control, electronic gearboxes.
Programming	Multi-tasking TrioBASIC system, maximum 10 user tasks. IEC61131-3 programming languages.
Servo Cycle	125µs minimum, 1ms default, 2ms max.
Memory	8 Mbyte user memory. 512,000 x 64 bit TABLE memory. Automatic flash EPROM program and data storage.
Real Time Clock	Capacitor backed for 10 days or power off.
VR	4096 global VR data in FLASH memory. (automatic-store)
Expansion Memory	Socket for Micro SD Card. Used for storing programs and/or data. Format: FAT32, up to 16 GBytes.
Power Input	600mA at 5V d.c.
Amplifier Enable Output	Normally open solid-state relay. Maximim load 100mA, maximum voltage 29V.
Analogue Outputs	4 Isolated 12 bit +/-10V or 8 isolated 12 bit +/-10V.
Analogue Inputs	2 x 12 bit 0 to 10V
Digital Inputs	16 Opto-isolated 24V inputs
Registration Inputs	8 shared with inputs 0 to 7.
Encoder Inputs	4 / 8 differential 5V inputs, 6MHz maximum edge rate
Stepper Outputs	4 / 8 differential step / direction outputs 2MHz max rate
Digital Outputs	8 Opto-isolated 24V outputs. Current sourcing (PNP) 250 mA. (max. 1A per bank of 8)
Product Code	P831 : Euro404, 4 axis stepper P832 : Euro404, 4 axis servo P833 : Euro408, 8 axis stepper P834 : Euro404, 8 axis servo





# MC464 EXPANSION MODULES

# 3



# MC464 Expansion Modules

## Assembly

A maximum of 7 half height modules or 3 full height modules may be fitted to the MC464. A system may be made using any combination of half and full height modules providing that the full height modules are the last to be attached.

### MODULE SLOT NUMBERS

**SLOT** Numbers are allocated by the system software in order, left to right, starting with the lower bus. Lower modules are allocated slots 0 to m, then the upper modules become slots m+1 to n. Finally, the Sync Encoder Port is allocated slot n+1. The Sync Encoder Port has **SLOT** number -1 in addition to the one allocated (1) in this sequence.

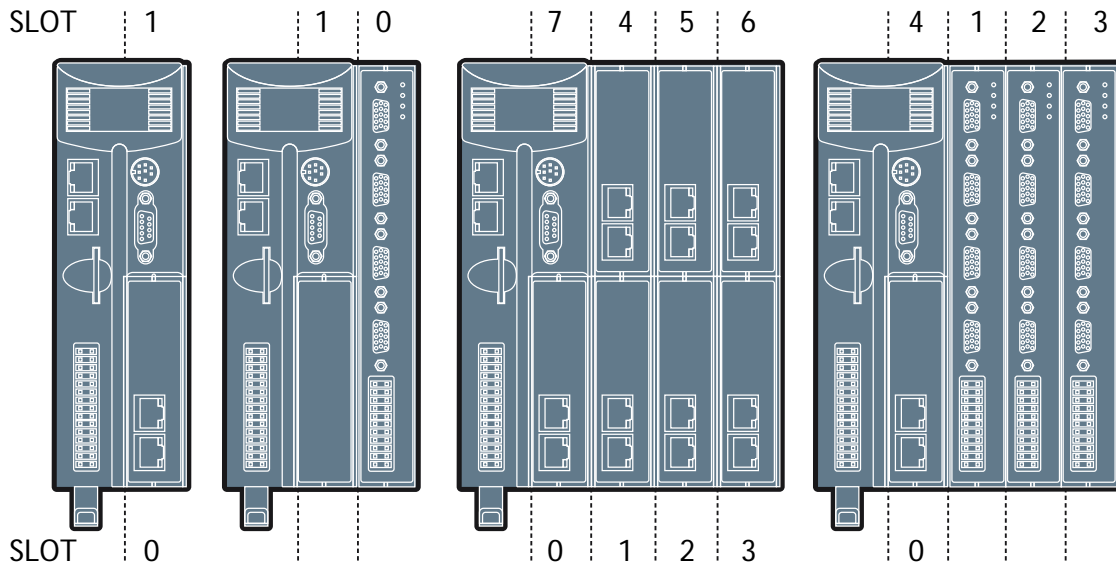

## FITTING EXPANSION MODULES

- Remove the 2 covers (B) if fitted to the MC464 or to the previous expansion module (C).
- Locate the 2 hooks at the front of the module, while holding the rear out at an angle
- Push forward to engage the hooks and at the same time swing the rear of the module in so as to locate the connector.
- Press the connector “home” once it is located.
- Tighten the screw (A) using the tool provided or a small coin
- Clip the provided covers (B) in place as shown.

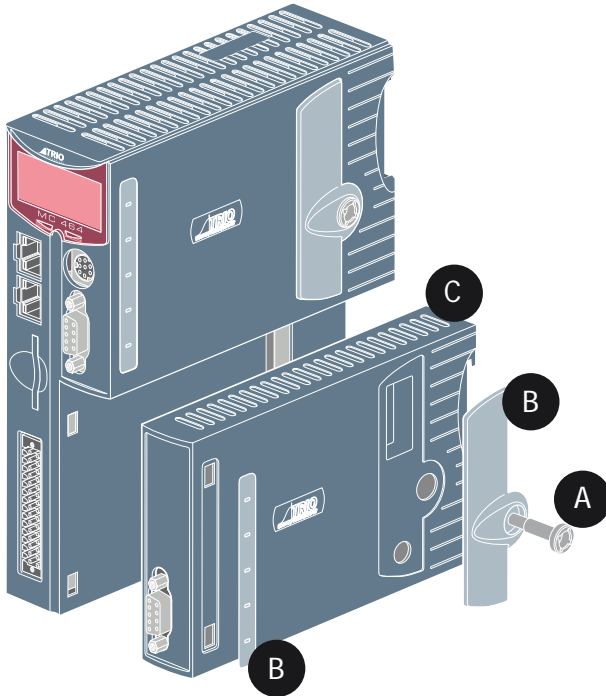

Removing modules is the reversal of the above procedure.

If the system is to be panel mounted, a kit (P8) comprising 2 x panel mounting brackets and 2 x countersunk screws may be purchased separately from your Trio distributor.

## RTEX Interface (P871)

For use with Panasonic amplifiers supporting the Panasonic Real Time Express (RTEX) network. Allows Plug & Play interconnection with Shielded twisted pair (TIA/EIA-568B CAT5e or more) Ethernet cables.

A single interface supports up to 32 axes on the RTEX network. The module comes with 2 axes enabled. Further axes can be enabled with Trio's Feature Enable Codes.

### REALTIME EXPRESS

The P871 communicates with up to 32 servo amplifiers using Ethernet Real Time Express. The physical layer is standard Ethernet connected in a ring. Each node has a transmit socket and a receive socket to allow easy connection. The maximum cable length between any 2 nodes is 60 meters and the overall network length is limited to 200 meters.



### RJ45 CONNECTOR (TX)



(Top connector) 100Mbps Panasonic RTEX transmit - connect to receive of first drive.

### RJ45 CONNECTOR (RX)



(Bottom connector) 100Mbps Panasonic RTEX receive - connect to transmit of last drive.

### TIME BASED REGISTRATION

Time based registration uses a 10MHz clock to record the time of a registration event which is then referenced to time stamps on the axis position from the digital drive network. An accurate registration position is then calculated. The 10MHz clock gives a time resolution of 100nsec. The position and speed of the axis are recorded so that the user can compensate for any fixed delays in the registration circuit.

Any time based registration input can be assigned to any Digital or Virtual axis. This makes the registration very flexible and enables multiple registration channels per axis. Each registration channel can be armed independently and assigned to an axis at any time.

### REGISTRATION CONNECTOR

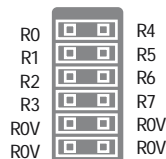

R0-R7 registration inputs (24V).

0V common 0V return.

Registration inputs can be allocated to any axis by software.

**LED FUNCTIONS**

LED	LED colour	LED function
ok	Green	ON=Module Initialised Okay
0	Red	ON=Module Error
1	Yellow	Status 1
2	Yellow	Status 2

## Sercos Interface (P872)

The sercos interface module is designed to control up to 16 servo amplifiers using the standard sercos fibre-optic ring. Benefits of this system include full isolation from the amplifiers and greatly reduced wiring.

For use with any sercos IEC61491 compliant drive. The module allows control of up to 16 axes via sercos with cycle times down to 250usec. Multiple sercos interface modules can be used to increase axes count to 64.

2, 4, 8 and 16 Mbit / sec

Software settable intensity

### SERCOS CONNECTIONS

Sercos is connected by 1mm polymer or glass fibre optic cable terminated with 9mm FSMA connectors. The sercos ring is completed by connecting TX to RX in a series loop. The maximum fibre cable length between 2 nodes is 40m for plastic optical fibre (POF) and 200m for hard clad silica (HCS). The total length for POF is 680m and 3,400 for HCS.



### CONNECTOR (RX)



(Top connector) sercos fibre-optic transmit. 9mm FSMA.

### CONNECTOR (TX)



(Bottom connector) sercos fibre-optic receive. 9mm FSMA.

### TIME BASED REGISTRATION

Time based registration uses a 10MHz clock to record the time of a registration event which is then referenced to time stamps on the axis position from the digital drive network. An accurate registration position is then calculated. The 10MHz clock gives a time resolution of 100nsec. The position and speed of the axis are recorded so that the user can compensate for any fixed delays in the registration circuit.

Any time based registration input can be assigned to any Digital or Virtual axis. This makes the registration very flexible and enables multiple registration channels per axis. Each registration channel can be armed independently and assigned to an axis on the fly.

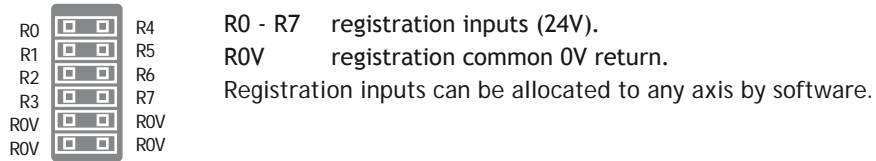

**REGISTRATION CONNECTOR****LED FUNCTIONS**

LED	LED colour	LED function
ok	Green	ON=Module Initialised Okay
0	Red	ON=Module Error
1	Yellow	Status 1
2	Yellow	Status 2

sercos phase	LED 1	LED 2
0	OFF	FLASH
1	OFF	ON
2	FLASH	OFF 1
3	ON	OFF 2
4	ON	ON

## SLM Interface (P873)

For use with drives supporting the Control Techniques SLM protocol. Each module supports 6 axes which can be individual drives or two drives using the CT Multi-ax concept.



### SLM CONNECTOR

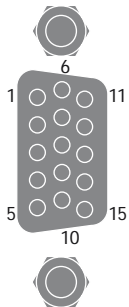

Pin	Upper D-Type	Lower D-Type
1	Com Axis 0	Com Axis 3
2	/Com Axis 0	/Com Axis 3
3	Hardware Enable	Hardware Enable
4	0V Output	0V Output
5	24V Output	24V Output
6	Com Axis 1	Com Axis 4
7	/Com Axis 1	/Com Axis 4
8	No Connection	No Connection
9	No Connection	No Connection
10	No Connection	No Connection
11	24V Output	24V Output
12	0V Output	0V Output
13	Com Axis 2	Com Axis 5
14	/Com Axis 2	/Com Axis 5
15	Earth / Shield	Earth / Shield

### TIME BASED REGISTRATION

Time based registration uses a 10MHz clock to record the time of a registration event which is then

referenced to time stamps on the axis position from the digital drive network. An accurate registration position is then calculated. The 10MHz clock gives a time resolution of 100nsec. The position and speed of the axis are recorded so that the user can compensate for any fixed delays in the registration circuit.

Any time based registration input can be assigned to any Digital or Virtual axis. This makes the registration very flexible and enables multiple registration channels per axis. Each registration channel can be armed independently and assigned to an axis on the fly.

### REGISTRATION CONNECTOR

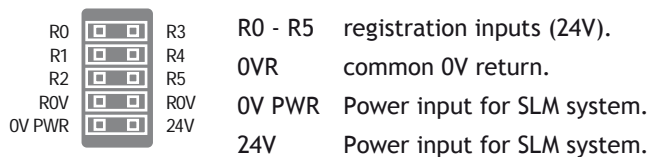

### LED FUNCTIONS

LED	LED Colour	LED Function
ok	Green	ON = Module initialised ok
0	Red	ON = Module error
1	Yellow	Status 1
2	Yellow	Status 2

## FlexAxis Interface (P874 / P879)

For use with Stepper, Analogue Servo & Piezo motors. The FlexAxis Interface is available in 4 axes (P879) and 8 axes (P874) versions.

Each axis provides a 16 bit analogue output, up to 8 x 24Vdc high speed registration inputs and a 6MHz encoder input. The encoder port can be configured to drive a stepper motor or an encoder simulation port, both at 2MHz.

### ENCODER CONNECTOR

Pin	Incremental Encoder	Pulse + Direction	Absolute Encoder
1	Enc. A n	Step+ n	Clock+ n
2	Enc. /A n	Step- n	Clock- n
3	Enc. B n	Direction+ n	n/c
4	Enc. /B n	Direction- n	n/c
5	0V Enc	0V Enc	0V Enc
6	Enc. Z n	Enable+ n	Data+ n
7	Enc. /Z n	Enable- n	Data- n
8	5V*	5V*	5V*
9	Enc A n+4	Step+ n4	Clock+ n+4
10	Enc /A n+4	Step- n4	Clock- n+4
11	Enc B n+4	Direction+ n+4	n/c
12	Enc /B n+4	Direction- n+4	n/c
13	Enc Z n+4	Enable+ n+4	Data+ n+4
14	Enc /Z n+4	Enable- n+4	Data- n+4
15	0V Enc	0V Enc	0V Enc

\*5V supply is limited to 150mA per axis.



Absolute encoder is only available on axes 4-7 on the P874 and on axes 2-3 on P879.

Connector	8 Axes (P874)	4 Axes (P879)
1	0 and 4	0
2	1 and 5	1
3	2 and 6	2
4	3 and 7	3

## MULTIFUNCTION CONNECTOR

The 22 pin multifunction connector provides terminals for 8 registration inputs, 8 voltage outputs and 4 hardware PSWITCH outputs.

## ANALOGUE OUTPUTS

8 +/-10V 16Bit analogue outputs are available for servo axis control (4 in the P879). Connect V0 as the velocity command signal for the first axis, V1 for the second axis and so on. The maximum load per axis together is 10mA.

## POSITION BASED REGISTRATION

Position based registration uses the encoder signal. When the registration event occurs the encoder position is latched in hardware. The speed of the axis is also recorded so that the user can compensate for any fixed electronic delays in the registration circuit. Flexible allocation of registration inputs to axes is provided. Each axis can have a number of registration events assigned to it and the source of these events can be from any of the registration channels.

The Flex Axis module has 8 registration inputs in addition to the Z mark for each axis. The first axis has 8 registration events which can be assigned to use any of the registration inputs or its own Z mark. The remaining axes have 2 registration events which can be assigned to use any of the registration inputs or their own Z mark.

## PSWITCH OUTPUTS

Inputs R4 to R7 are bi-directional and can be used as outputs for high accuracy PSWITCH operation. When used in this mode, the outputs are controlled by the position value of an axis within the same P874 / P879 module.



## MULTIFUNCTION CONNECTOR PIN OUT

DAC 0V		DAC 0V	0V	DAC common 0V return
DAC 0V		DAC 0V	V0 - V7	Voltage outputs
V0		V4	R0 - R3	24V Registration Inputs
V1		V5	R4/PS4 - R7/PS7	Bidirectional 24V registration In/24V: PSWITCH outputs
V2		V6	Inputs / 24V	PSwitch outputs
V3		V7	0V PWR	Power Input
R0		R4/PS4	24V	Power Input
R1		R5/PS5		
R2		R6/PS6		
R3		R7/PS7		
0V PWR		24V		



4 axis version uses voltage outputs V0 - V3 only.

## LED FUNCTIONS

LED	LED Colour	LED Function
ok	Green	ON = Module initialised ok
0	Red	ON = Module Error
1	Yellow	Status 1
2	Yellow	Status 2

## EtherCAT Interface (P876)

For use with EtherCAT compliant drives, this module allows control of up to 64 axes via standard shielded twisted pair (TIA/EIA-568B CAT5e or more) Ethernet cables. Multiple EtherCAT Interface Modules can be used.

EtherCAT is an open, high performance ethernet based fieldbus system, which has been integrated into several IEC standards (IEC 61158, IEC 61784 and IEC61800). It is a high performance, deterministic protocol, with high bandwidth usage, low latency and low communication jitter. Various network topologies are supported, including line, tree or star. The EtherCAT compliant servo amplifiers from any number of vendors may be included in a network.

The module supports both the CANopen and servo drive (sercos, IEC 61491) EtherCAT profiles, along with the mailbox transfer protocol to exchange configuration, status and diagnostic information between the master and slave.



### RJ45 CONNECTOR



100 base-T Ethernet (EtherCat Master).

### TIME BASED REGISTRATION

Time based registration uses a 10MHz clock to record the time of a registration event which is then referenced to time stamps on the axis position from the digital drive network. An accurate registration position is then calculated. The 10MHz clock gives a time resolution of 100nsec. The position and speed of the axis are recorded so that the user can compensate for any fixed delays in the registration circuit.

Any time based registration input can be assigned to any Digital or Virtual axis. This makes the registration very flexible and enables multiple registration channels per axis. Each registration channel can be armed independently and assigned to an axis on the fly.

## REGISTRATION CONNECTOR

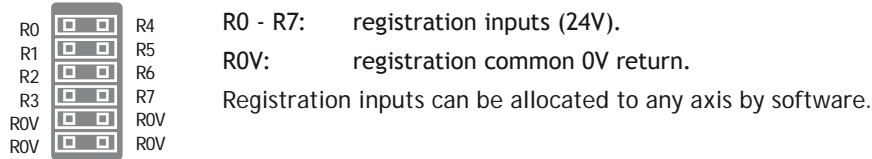

## LED FUNCTIONS

LED	LED colour	LED function
ok	Green	ON=Module Initialised Okay
0	Red	Quick Flash = Module Error Slow Flash = Not in operational state
1	Yellow	Status 1
2	Yellow	Network Activity

## Anybus-CC Module (P875)

Open communications is an important aspect to any control system. This module adds support for the Anybus CompactCom device modules.

Anybus-CC is a plug-in module supporting all major Fieldbus and Ethernet networks. Its innovative design and versatile functionality offers the Anybus-CC optimal flexibility for OEM manufacturers.

The Anybus modules can be found at: [www.anybus.com](http://www.anybus.com)



Anybus CompactCom Module shown for illustration only. Anybus CC Modules may be purchased separately.



### ANYBUS MODULE FITTING

Push the Anybus® module (A) into the Trio Expansion Interface taking care to keep its base in contact with the PCB and align guide slots (B) with the connector rails inside.

Ensure that the moulded hooks (C) on the lower front edge of the Anybus® module locate under the P875 PCB at the front.

When the module is flush with the face of the Trio Expansion Interface, tighten the two “Torx” head screws (D) to locate the two lugs (E) and secure the Anybus® module.

To remove the module, reverse this procedure.

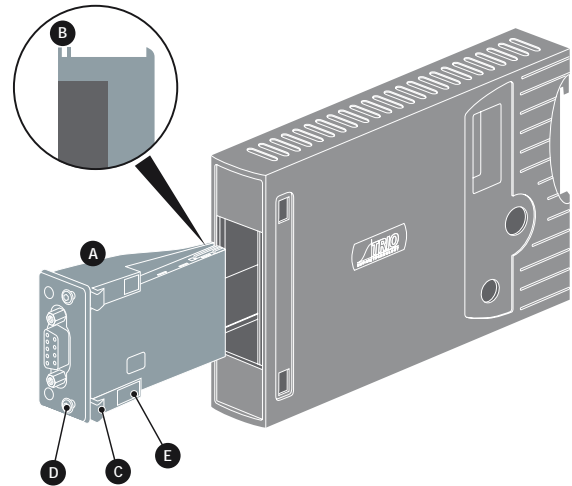





# I/O EXPANSION MODULES

# 4



# General Description of I/O Modules

Trio Motion Technology's range of digital and analogue input/output expansion modules are designed to enable simple and scalable I/O extension for Trio's *Motion Coordinators*. In addition to 24V input, output and bi-directional modules, there are relay and analogue I/O modules.

The *Motion Coordinator* I/O expansion system uses CANbus to reduce wiring and allow input/output modules to be distributed remotely. Up to 32 Digital modules and up to 4 Analogue modules may be added to the system.

All CAN Input, Output and I/O modules are DIN rail mounted with the I/O connections located conveniently on the front face. They have been designed with a spaced-saving footprint only 26mm wide so allowing large amounts of Digital and Analogue I/O to be packed in an area no bigger than the average PLC. Address selection is simply done by setting DIP switches that are neatly located under the pull-up flap. LEDs show the I/O state and indicate an error code for straight forward system commissioning and de-bugging.

To install CAN modules, see "Installing the CAN I/O Modules" on page 5-10.

CANbus is used for communication and control between the *Motion Coordinator* and the CAN I/O modules. CANbus is a tried and tested, well known industrial data link which is reliable, noise immune and flexible. All CAN I/O modules are compatible with any *Motion Coordinator* that has a CANbus port and they support various CAN protocols.

## PRODUCT CODE:

CAN 16-Output Module	P317
CAN 16-Input Module	P318
CAN 16-I/O Module	P319
CAN Analogue I/O Module	P326
CAN 8-Relay Module	P327

# CAN 16-Output Module (P317)

The Trio CAN 16 Output module offers a compact DIN rail mounted relay input expansion capability for all Trio *Motion Coordinators*. Using remote I/O on the Trio CANbus can significantly reduce the machine wiring.

Up to 16 output modules may be connected to the CAN network which may be up to 100m long. This provides up to 256 distributed output channels at 24Vdc level. All outputs are short-circuit proof and completely isolated from the CANbus. P317 modules may be mixed on the same bus, with other types of Trio CAN I/O modules on the same network to build the I/O configuration required for the system.

Convenient disconnect terminals are used for all I/O connections.

## CANBUS

The CANbus port has over voltage and reverse polarity protection. Various protocols can selected using the configuration switches.

## 24V OUTPUT CHANNELS

The P317 has two banks of eight outputs, both banks of outputs are electrically isolated and require their own 24V and 0V. Output channels have a protected 24V sourcing output connected to the output pin. The output circuit has electronic over-current protection and thermal protection which shuts the output down when the current exceeds 250mA.

Care should be taken to ensure that the 250mA limit for the output circuit is not exceeded, and that the total load for the group of 8 outputs does not exceed 1 amp.

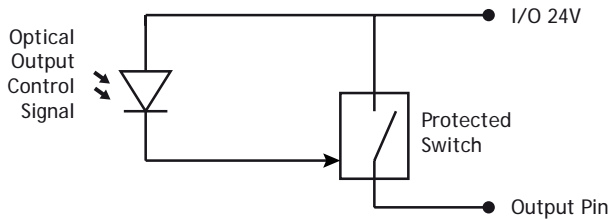
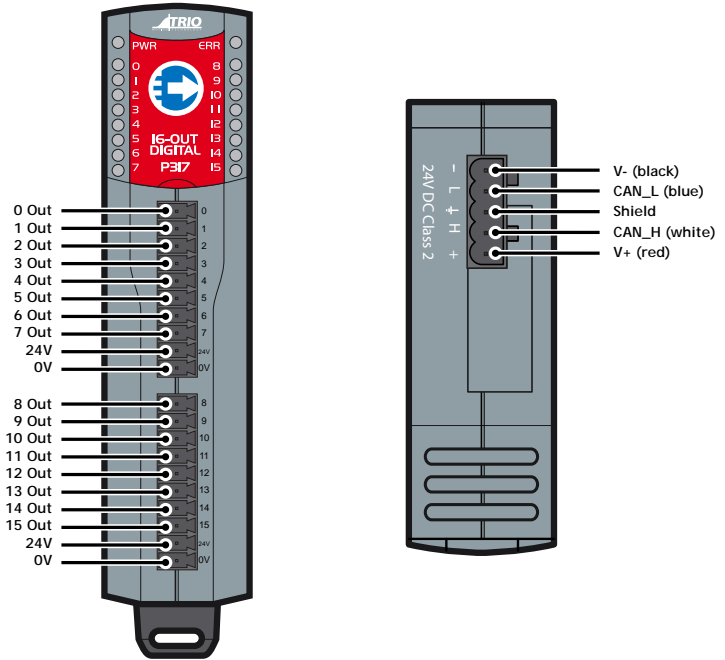

With no load, the outputs may 'float' up to 24V even when of. Fit a load resistor, for example 10k, when bench testing the P317.

## LED INDICATORS

The green power (PWR) LED and red error (ERR) LED display the status of the CAN I/O module. The actual status displayed will depend on the protocol selected.

The status LEDs marked 0 - 15 represent the output channels 0 - 15 of the module. The actual outputs as seen by the *Motion Coordinator* software will depend on the modules' address.

## CONFIGURATION SWITCHES

The switches are hidden under the display window. These can be adjusted to set the module address, protocol and data rate.

## SPECIFICATION P317

Outputs:	16 24 Volt output channels with 2500V isolation
Configuration:	16 output channels
Output Capacity:	1A per bank of 250mA / channel
Protection:	Outputs are overcurrent and over temperature protected
Indicators:	Individual status LED's
Address Setting:	Via DIP switches
Power Supply:	24V dc, Class 2 transformer or power source 18 ... 29V dc / 1.5W.
Mounting:	DIN rail mount
Size:	26mm wide 85mm deep 130mm high
Weight:	128g
CAN:	500kHz, Up to 256 expansion I/O channels
EMC:	EN 61000-6-2 : 2005 Industrial Noise Immunity / EN 61000-6-4 : 2007 Industrial Noise
CAN protocol:	Trio CAN I/O or CANopen DS401.

# CAN 16-Input Module (P318)

The Trio CAN 16 Input module offers a compact DIN rail mounted relay input expansion capability for all Trio *Motion Coordinators*. Using remote I/O on the Trio CANbus can significantly reduce the machine wiring.

Up to 16 input modules may be connected to the CAN network which may be up to 100m long. This provides up to 256 distributed input channels at 24Vdc level. All input points are high level (24V in = ON) and completely isolated from the CANbus. P318 modules may be mixed on the same bus, with other types of Trio CAN I/O modules on the same network to build the I/O configuration required for the system.

Convenient disconnect terminals are used for all I/O connections.

## CANBUS

The CANbus port has over voltage and reverse polarity protection. Various protocols can be selected using the configuration switches.

## 24V INPUT CHANNELS

The P318 has two banks of eight inputs, both banks of outputs are electrically isolated and have independent 0V. Input channels are opto-isolated 24V, which are designed to be ON when the input voltage is greater than 18 Volts and OFF when the signal voltage is below 2V. The input has a 6k8 resistor in series and so provides a load of approximately 3.5mA at 24V.

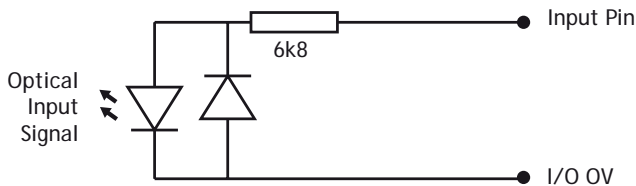

## LED INDICATORS

The green power (PWR) LED and red error (ERR) LED display the status of the CAN I/O module. The actual status displayed will depend on the protocol selected.

The status LEDs marked 0 - 15 represent the input channels 0 - 15 of the module. The actual input as seen by the *Motion Coordinator* software will depend on the modules' address.

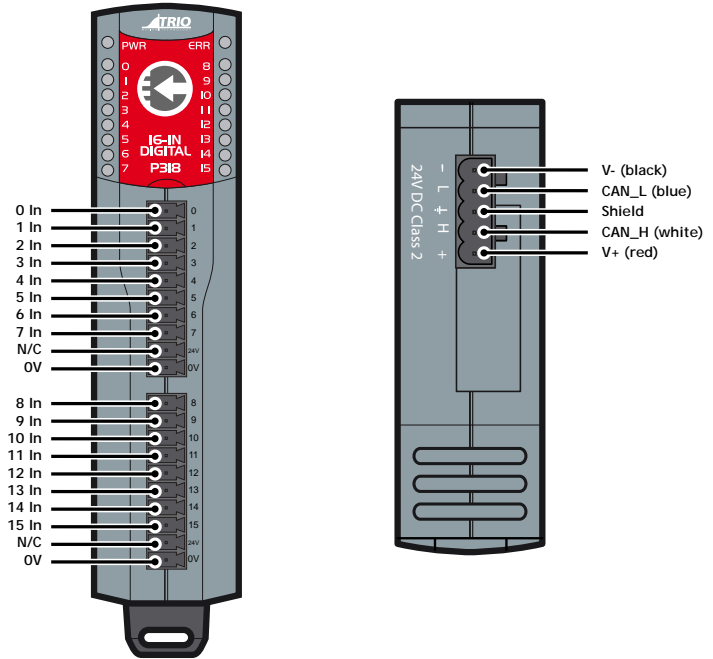

## CONFIGURATION SWITCHES

The switches are hidden under the display window. These can be adjusted to set the module address, protocol and data rate.

## SPECIFICATION P318

Inputs:	16 24 Volt input channels with 2500V isolation
Configuration:	16 input channels
Protection:	Inputs are reverse polarity protected
Indicators:	Individual status LED's
Address Setting:	Via DIP switches
Power Supply:	24V dc, Class 2 transformer or power source 18 ... 29V dc / 1.5W.
Mounting:	DIN rail mount
Size:	26mm wide 85mm deep 130mm high
Weight:	128g
CAN:	500kHz, Up to 256 expansion I/O channels
EMC:	EN 61000-6-2 : 2005 Industrial Noise Immunity / EN 61000-6-4 : 2007 Industrial Noise Emissions
CAN protocol:	Trio CAN I/O or CANopen DS401.



# CAN 16-I/O Module (P319)

The Trio CAN 16 Input/ Output module offers a compact DIN rail mounted relay input expansion capability for all Trio *Motion Coordinators*. Using remote I/O on the Trio CANbus can significantly reduce the machine wiring.

Up to 16 I/O modules may be connected to the CAN network which may be up to 100m long. This provides up to 256 distributed bi-directional input/output channels at 24Vdc level. All input points are high level (24V in = ON) all outputs are short-circuit proof and the I/O is completely isolated from the CANbus. P319 modules may be mixed on the same bus, with other types of Trio CAN I/O modules on the same network to build the I/O configuration required for the system.

Convenient disconnect terminals are used for all I/O connections.

## CANBUS

The CANbus port has over voltage and reverse polarity protection. Various protocols can selected using the configuration switches.

## 24V INPUT/ OUTPUT CHANNELS

The P319 has two banks of eight bi-directional input/ outputs, both banks are electrically isolated and require their own 24V and 0V. Input/output channels are bi-directional, so can be used as an input or output. Bi-directional inputs have a protected 24V sourcing output connected to the same pin. If the output is unused, the pin may be used as an input in the program. The output circuit has electronic over-current protection and thermal protection which shuts the output down when the current exceeds 250mA.

Care should be taken to ensure that the 250mA limit for the output circuit is not exceeded, and that the total load for the group of 8 outputs does not exceed 1 amp.

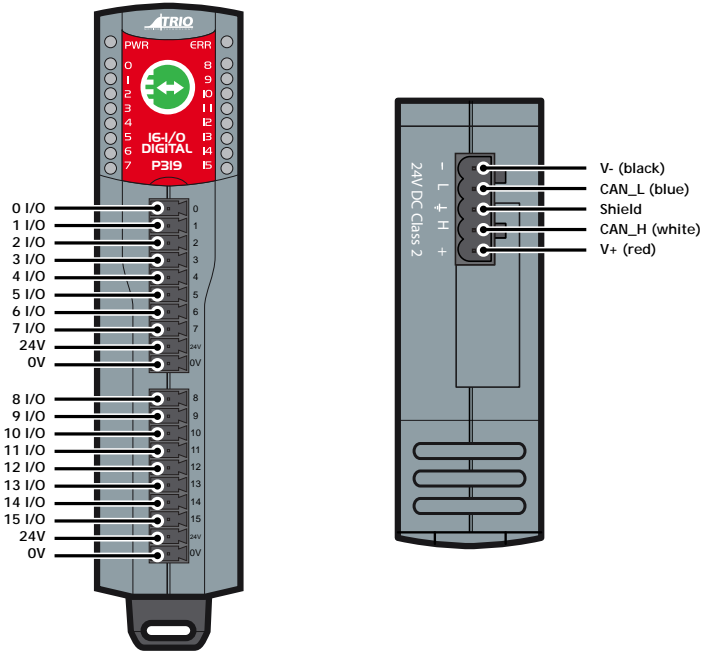

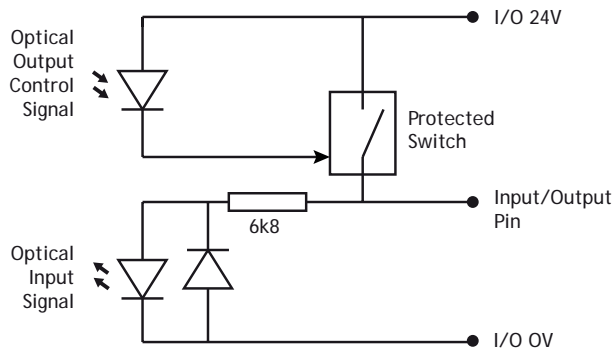

## LED INDICATORS

The green power (PWR) LED and red error (ERR) LED display the status of the CAN I/O module. The actual status displayed will depend on the protocol selected.

The status LEDs marked 0 - 15 represent the I/O channels 0 - 15 of the module. The actual I/O as seen by the *Motion Coordinator* software will depend on the modules' address.

## CONFIGURATION SWITCHES

The switches are hidden under the display window. These can be adjusted to set the module address, protocol and data rate.

## SPECIFICATION P319

Inputs:	16 24 Volt input channels with 2500V isolation
Outputs:	16 24 Volt output channels with 2500V isolation
Configuration:	16 input/output channels
Output Capacity:	Outputs are rated at 250mA/channel. (1 Amp total/bank of 8 I/O's)
Protection:	Outputs are overcurrent and over temperature protected
Indicators:	Individual status LED's
Address Setting:	Via DIP switches
Power Supply:	24V dc, Class 2 transformer or power source. 18 ... 29V dc / 1.5W.
Mounting:	DIN rail mount
Size:	26mm wide 85mm deep 130mm high
Weight:	128g
CAN:	500kHz, Up to 256 expansion I/O channels
EMC:	EN 61000-6-2 : 2005 Industrial Noise Immunity / EN 61000-6-4: 2007 Industrial Noise
CAN protocol:	Trio CAN I/O or CANopen DS401.

# CAN Analogue I/O Module (P326)

The Trio CAN Analogue I/O module offers a compact DIN rail mounted relay output expansion capability for all Trio *Motion Coordinators*. Using remote I/O on the Trio CANbus can significantly reduce the machine wiring.

Up to 4 analogue modules may be connected to the CAN network which may be up to 100m long. This provides up to 32 distributed analogue inputs and 16 analogue outputs . Each module provides 8 channels of 12-bit analogue inputs (+/-10v) and 4 channels of 12-bit (+/-10v) analogue outputs. All analogue I/O are completely isolated from the CANbus. P326 modules may be mixed on the same bus, with other types of Trio CAN I/O modules on the same network to build the I/O configuration required for the system.

Convenient disconnect terminals are used for all I/O connections.

## CANBUS

The CANbus port has over voltage and reverse polarity protection. Various protocols can be selected using the configuration switches.

## INPUT TERMINALS

The 8 analogue inputs are single-ended and have a common 0V. Analogue input nominal impedance = 42k Ohm.

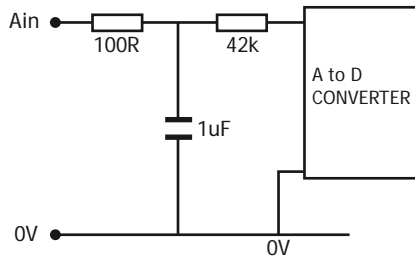

## OUTPUT TERMINALS

The 4 analogue outputs are single-ended and have a common 0V. Analogue output nominal impedance = 100 Ohm.

The recommended minimum load resistance on the output is 2k Ohm.

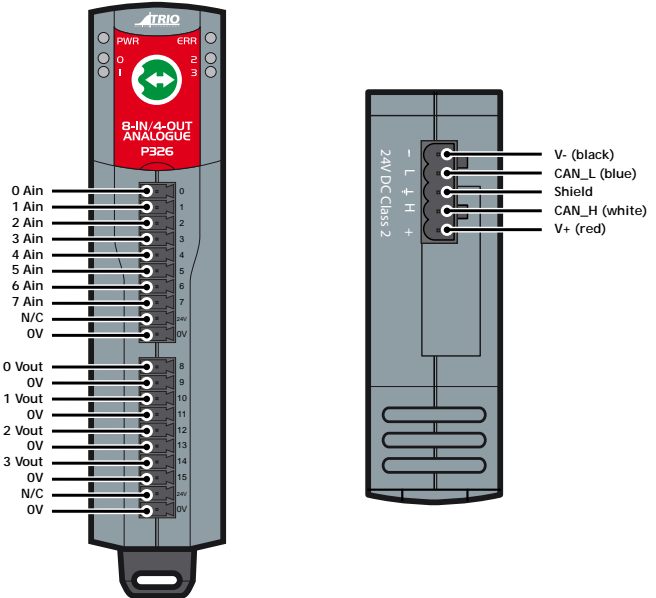

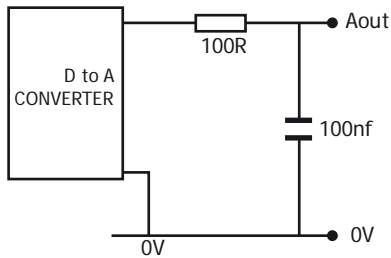

### LED INDICATORS

The green power (PWR) LED and red error (ERR) LED display the status of the CAN I/O module. The actual status displayed will depend on the protocol selected.

The status LEDs marked 0 - 3 are only used to display an error.

### CONFIGURATION SWITCHES

The switches are hidden under the display window. These can be adjusted to set the module address, protocol and data rate.

### SPECIFICATION P326

Analogue Inputs:	8 +/-10 Volt inputs with 500V isolation from CAN bus.
Resolution:	12 bit.
Protection:	Inputs are protected against 24V over voltage.
Analogue Outputs:	4 +/-10 Volt outputs with 500V isolation from CAN bus.
Resolution:	12Bit.
Address Setting:	Via DIP switches.
Power Supply:	24V dc, Class 2 transformer or power source. 18 ... 29V dc / 1.5W.
Mounting:	DIN rail mount.
Size:	26mm wide 85mm deep 130mm high.
Weight:	128g
CAN:	500kHz, Up to 32 analogue input channels and 16 analogue output channels.
EMC:	EN 61000-6-2 : 2005 Industrial Noise Immunity / EN 61000-6-4 : 2007 Industrial Noise Emissions.
CAN Protocol:	Trio CAN I/O or CANopen DS401.

# CAN 8-Relay Module (P327)

The Trio CAN 8 Relay module offers a compact DIN rail mounted relay output expansion capability for all Trio *Motion Coordinators*. Using remote I/O on the Trio CANbus can significantly reduce the machine wiring.

Up to 16 relay modules may be connected to the CAN network which may be up to 100m long. This provides up to 128 distributed low power relay channels at up to 30Vdc or 49Vac. Four of the 8 channels in each module are change-over contact and the remaining four are normally-open contacts. All output points are voltage-free contacts and are completely isolated from the CANbus. P327 modules may be mixed on the same bus, with other types of Trio CAN I/O modules on the same network to build the I/O configuration required for the system.

Convenient disconnect terminals are used for all I/O connections.

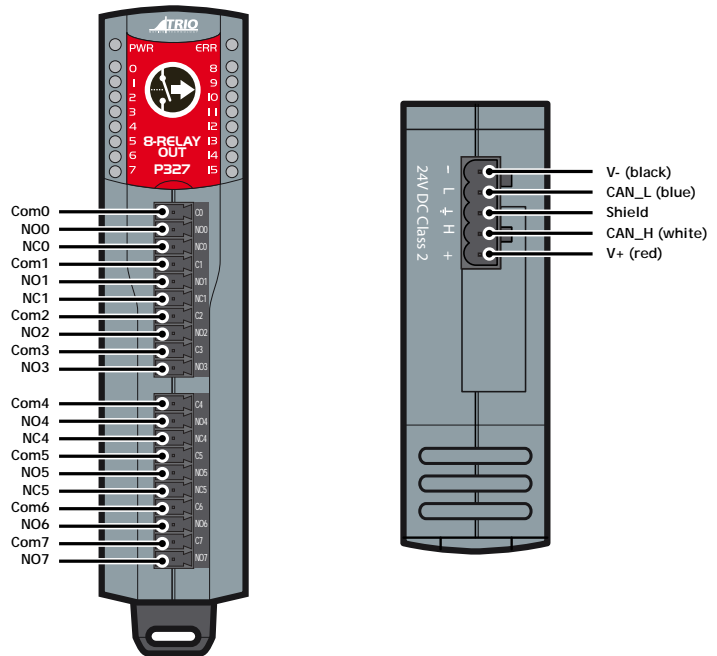

**DO NOT CONNECT 24V AND 0V TO THE BOTTOM TWO PINS (COM3, NO3 AND COM7, NO7) ON THE CONNECTORS AS THE PIN CONNECTIONS ARE DIFFERENT TO THE DETAILS MOLDED INTO THE PLASTIC CASE.**

## CANBUS

The CANbus port has over voltage and reverse polarity protection. Various protocols can be selected using the configuration switches.

## RELAY CHANNELS

Each relay channel is an independent isolated voltage free set of contacts. Channels 0, 1, 4 and 5 are change-over contacts and channels 2, 3, 6 and 7 are normally open contacts only. Each contact is rated at 30Vdc (24 Watts) or 49Vac (62.5 VA). Absolute maximum current for any one contact is 1A under all conditions.

Relay contacts do not have built-in suppression so external EMC suppression components must be fitted as required.



USING THE RELAY IN A CIRCUIT WHERE THE RELAY WILL BE ON CONTINUOUSLY FOR LONG PERIODS (WITHOUT SWITCHING) CAN LEAD TO UNSTABLE CONTACTS, BECAUSE THE HEAT GENERATED BY THE COIL ITSELF WILL AFFECT THE INSULATION, CAUSING A FILM TO DEVELOP ON THE CONTACT SURFACES. BE SURE TO USE A FAIL-SAFE CIRCUIT DESIGN THAT PROVIDES PROTECTION AGAINST CONTACT FAILURE OR COIL BURNOUT.

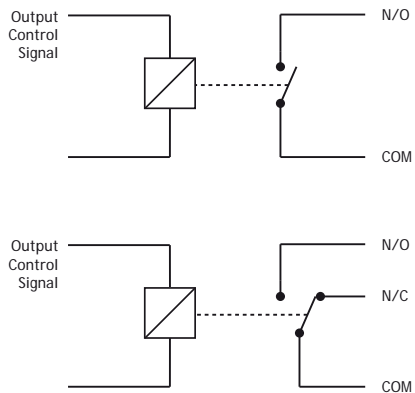

## LED INDICATORS

The green power (PWR) LED and red error (ERR) LED display the status of the CAN I/O module. The actual status displayed will depend on the protocol selected.

The status LEDs marked 0 - 7 represent the relay channels 0 - 7 of the module. The actual output as seen by the *Motion Coordinator* software will depend on the modules' address.

## CONFIGURATION SWITCHES

The switches are hidden under the display window. These can be adjusted to set the module address, protocol and data rate.

## SPECIFICATION P327

Outputs:	8 relays 30Vdc / 49Vac
Configuration:	4 NO relays and 4 change-over relays
Output Capacity:	Maximum switching power per contact: 62.5 VA, 24W (dc) Max current 1 Amp.
Protection:	Outputs to CAN circuit isolation, 1,500V dc.
Indicators:	Individual status LED's
Address Setting:	Via DIP switches
Power Supply:	24V dc, Class 2 transformer or power source. 18 ... 29V dc / 1.5W.
Mounting:	DIN rail mount
Size:	26mm wide 85mm deep 130mm high
Weight:	174g

CAN:	500kHz, Up to 128 expansion relay channels
EMC:	EN 61000-6-2: 2005 Industrial Noise Immunity / EN 61000-6-4: 2007 Industrial Noise
CAN protocol:	Trio CAN I/O or CANopen DS401

## Controller I/O mapping

### DIGITAL I/O ORDER

The controller has different sources of I/O which it has to map to IN and OP. This includes I/O from built in I/O, module I/O and CAN I/O. All of these sources are mapped in blocks of 8, some modules have more than 8 I/O so will take up multiple blocks. Any modules using less than 8 will consume a block of 8 and the remainder of the block will be virtual I/O.

By default built in controller I/O is mapped first followed by module I/O then CAN I/O. **MODULE \_ IO \_ MODE** is used to configure a different order or to disable the module I/O. When mapping the blocks of separate input and outputs the controller will overlap any inputs and outputs. Please note that bi-directional I/O cannot be split so can cause gaps in the I/O map.

All supported CAN protocols are mapped into the CAN section. For example a system with a MC464, FlexAxis 8, 1 CAN input and 1 CAN output module would be mapped as follows.

I/O source	Inputs	Outputs	I/O
MC464 I/O	0-7		8-15
FlexAxis 8	16-19		20-23
CAN address 0	24-40	24-40	

The FlexAxis is mapped to one block of I/O, as only 4 pins are bi-directional, outputs 16-19 are now virtual.

A different system using a MC464, EtherCAT, 1 CAN input and 1 CAN output module would be mapped as follows.

I/O source	Inputs	Outputs	I/O
MC464 I/O	0-7		8-15
Ethercat	16-23		
CAN address 0	24-40	16-23	

You can see that the EtherCAT inputs and CAN Output module are mapped to the same numbers. It is important to remember that the IN and OP are separate unless they are combined in a bi-directional I/O point.

### ANALOGUE I/O ORDER

Up to 32 CAN analogue inputs can be added to the system these are mapped to AIN in order of the module address. Analogue inputs are mapped as follows:

AIN	Source
0 to 31	CAN analogue inputs
32-33	Built in analogue inputs
33+	Module analogue inputs

Analogue outputs are mapped to AOUT in order of the module address starting at 0.

## TrioCANv2 Protocol

### GENERAL DESCRIPTION

The MC4xx range controllers by default will use TrioCANv2 protocol, this has various enhancements of previous versions of TrioCAN. The protocol allows for a combination of current and older CAN I/O modules though not all features of TrioCANv2 will be available if a P325, P315 or P316 module is used.

Enhancements to the protocol allow for the following:

- Increase the number of CAN inputs to 256
- Increase the maximum number of CAN outputs to 256
- Increase the total sum of Inputs and Outputs to 512 (bi-directional I/O counts as 1 input and 1 output)
- Allow new analogue output functionality
- Recognise digital input modules
- Recognise digital output modules
- Allow up to 32 digital modules by overlapping input and output addresses.
- Allow expansion module registration inputs and hardware PSWITCH outputs to be used as I/O
- Improved error handling - any error on the network is reported to the controller



If you need to revert to TrioCANv1 protocol you can set `CANIO _ MODE` and `MODULE _ IO _ MODE`. When using `CANIO _ MODE=1` all digital input, output and relay modules are treated as bi-directional I/O modules.

These changes will impact how you address the CAN I/O modules and how the I/O is mapped into the controller.



## PROTOCOL SELECTION

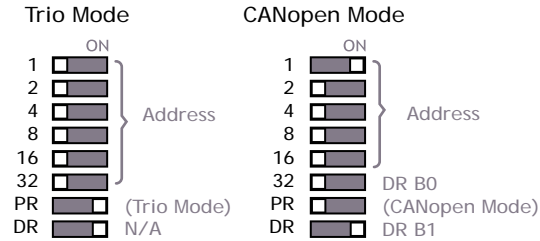

TrioCAN (all versions) can be selected on the CAN I/O modules using the protocol (PR) switch. When the controller initialises the CAN network it will tell the module to either use TrioCANv1 or TrioCANv2. It is recommended to leave the controller using TrioCANv2 however TrioCANv1 can be manually set in the controller using **CANIO \_ MODE**.



The data rate is fixed to 500kHz for TrioCANv2 Protocol, the data rate (DR) switch has no function. It is not possible to mix the CAN I/O modules which are running the TrioCANv2 protocol with DeviceNet equipment or CANopen devices on the same network

## CONTROLLER SETUP

All *Motion Coordinators* are configured by default to look for a TrioCAN network, MC4xx range controllers will automatically use TrioCANv2 if the modules on the network all support it. To force the controller to always use TrioCANv1 you can set **CANIO \_ MODE**.

To automatically search the CAN bus for TrioCAN modules on power up, **CANIO \_ ADDRESS** must be set to 32. There is no need to set this as it is the default value.

There are various system parameters available on the controller to check and change the status of the TrioCAN network, these include **CANIO \_ STATUS**, **CANIO \_ ADDRESS**, **CANIO \_ ENABLE** and **CANIO \_ MODE**.

When choosing which I/O devices should be connected to which channels the following points need to be considered:

- Inputs 0 - 63 ONLY are available for use with system parameters which specify an input, such as **FWD \_ IN**, **REV \_ IN**, **DATUM \_ IN** etc.
- The built-in I/O channels have the fastest operation <1mS
- CAN input modules with addresses 0-3 have the next fastest operation up to 2mS
- The remaining CAN input modules operate up to 20mS
- Outputs are set on demand.

## UPDATE RATES

### DIGITAL I/O

The digital I/O are cascaded through the modules, this means that lower address modules have a higher update rate.

Function	Update rate
Inputs address 0-3	2ms, no more than 50ms when state unchanged
Inputs address 4-11	10ms, no more than 50ms when state unchanged
Inputs address 12-15	20ms, no more than 50ms when state unchanged
Output address 0-3	5ms or on change of state
Output address 4-7	6ms
Output address 8-11	6ms (offset by 2ms from outputs address 4-7)
Output address 12-15	6ms (offset by 4ms from outputs address 4-7)

## ANALOGUE I/O

Analogue inputs have a standard operation which is enabled by default. Some applications require higher speed updates for example when using the analogue inputs as feedback into a servo loop.

Function	Update rate
Analogue Inputs, standard mode	10ms
Analogue Inputs fast mode	2ms
Analogue outputs	On state change

Standard operation is selected by default by the analogue module on power up. Fast operation has to be selected by executing the following **BASIC** in a configuration or startup program:

```
CAN(-1, 5, 4, $50, 8 ,1)
CAN(-1, 7, 4, $04, module_address, $00, $20, $00, $00, $00, $01)
```

## DIGITAL CAN I/O ADDRESSING

To enable up to 32 modules on the TrioCANv2 network and up to 512 I/O points Inputs and Outputs are addressed separately. There are 16 addresses (0-15) available for input modules and 16 addresses (0-15) available for outputs. Bi-directional modules take the same address from both the input and output range. There must be no gaps in the input address range, but gaps are allowed in the output address range.



Relay modules are addressed as per digital outputs, they use a block of 16 outputs even though they only have 8.

The total number of digital outputs, digital inputs and total digital I/O are reported by the system parameters NIN, NOP, NIO. The digital configuration is also reported in the startup message.



It is important to remember that **IN** and **OP** are only connected if you are using a bi-directional module. When using Input and Output modules with the same address **IN(x)** and **OP(x)** can be physically different I/O. If you need to read the state of an output you should use **READ \_ OP(x)**.

For example a system with 5 CAN 16-Input, 2 16-IO, 7 16-Output and one Relay module could be mapped as per the table below. The CAN I/O start at 16 as the controller has 16 I/O built-in and no module I/O. The start position will move depending on the number of built in I/O and module I/O.

I/O source	Inputs	Outputs	Relay	I/O
Controller I/O	0-7			8-15
CAN address 0				16-31
CAN address 1				32-47
CAN address 2	48-63	48-63		
CAN address 3	64-79	64-79		
CAN address 4	80-95	80-95		
CAN address 5	96-111	96-111		
CAN address 6	112-127	112-127		
CAN address 7			128-135 (136-143 virtual)	
CAN address 8		144-159		
CAN address 9		160-175		

You can see from this chart how the input and output modules are allowed to have overlapping addresses. Bi-directional I/O modules must have a unique address. The relay module only has 8 outputs but uses 1 bank of 16 outputs.



**TRIOCAN (V1) TREATS ALL MODULES AS BI-DIRECTIONAL I/O AND SO EVERY MODULE MUST HAVE A UNIQUE ADDRESS. THE TOTAL NUMBER OF I/O POINTS IS LIMITED TO 256 AND THE NETWORK IS LIMITED TO 15 MODULES.**

### ANALOGUE I/O ADDRESSING

The address switches on the analogue I/O modules will affect the order in which the I/O is mapped into AIN and AOUT. The first analogue module should be address 16 the second to 17 etc, there should be no gaps in the analogue I/O addressing. The addresses are set as a binary sum so for address 17 both switch 16 and 1 must be ON.

The total number of analogue outputs, analogue inputs and total analogue I/O are reported by the system parameters **NAOUT**, **NAIN**, **NAIO**. The analogue configuration is also reported in the startup message.

The analogue I/O are addressed as per the following table.

Address	AIN	AOUT
16	0-7	0-3
17	8-15	4-7
18	16-23	8-11
19	24-31	12-15

Trio Protocol  
Address = 16  
Analogue Inputs 0..7

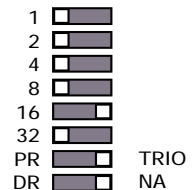

## ERROR CODES

When there is a problem with the TrioCANv2 network an error code is displayed on the LED's. All CAN I/O modules have a power LED (PWR) and an error LED (ERR). The power led should be illuminated while the 24V is applied to the CAN connector and the error LED will turn ON when there is an error. The actual error can be read from the status LED's



You can detect which modules have errors by reading `CANIO _ STATUS` in the motion *coordinator*

## DIGITAL INPUT, OUTPUT AND I/O MODULES

When there is an error the left bank of LED's will flash and the ERR LED will be ON. The error code will be displayed as a binary number on LED's 8-11

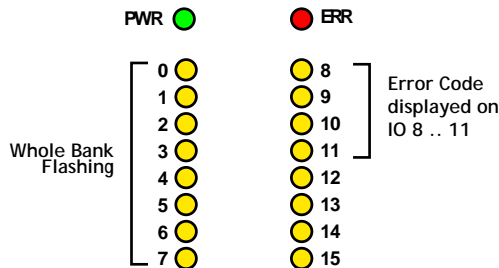





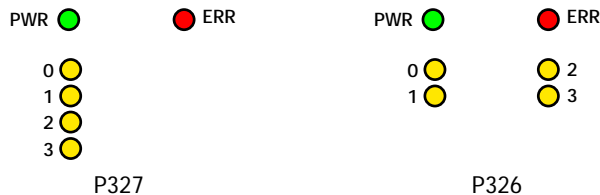

















## Relay module and Analogue I/O module

When there is an error the error code will be displayed as a binary number on LED's 0-3 and the ERR LED will be ON.



## ERROR CODES

Once the binary number has been read from the CAN I/O LED's then the error is as per the table below. Please note that only the error LED's are shown.

Code	P317, P318, P319, P327 LEDs	P326 LEDs	Error Description
1			Invalid Protocol
2			Invalid Module Address
3			Invalid Data Rate
4			Uninitialised
5			Duplicate Address
6			Start Pending
7			System Shutdown
8			Unknown Poll
9			Poll Not Implemented
10			CAN Error
11			Receive Data Timeout

## TROUBLESHOOTING

If the network configuration is incorrect 2 indications will be seen: The CAN module will indicate an error and the *Motion Coordinator* will report the wrong number of digital or analogue I/O.

If the error is 'uninitialised' then please check:

- Terminating 120 Ohm Network Resistors fitted?
- 24Volt Power to Network?
- Are the addresses correct?

- Have you power cycled the I/O modules after setting the address?
- Cable used is the correct CAN bus specification?
- Is `CANIO _ ADDRESS=32`?

If the network is OK but you are having I/O problems please check:

- 24Volt Power to each I/O bank required?
- You are using the correct I/O in the controller?
- `MODULE _ IO _ MODE` is set as you expect?
- `CANIO _ MODE` is set as you expect?

If the network stops during use please check:

- Terminating 120 Ohm Network Resistors fitted?
- The CAN cable is shielded with the shields correctly connected to earth

Cable used is the correct CAN bus specification?

- Connectors/ wires are not loose

## CANopen DS401

### GENERAL DESCRIPTION

The CAN modules can support CANopen DS401 so that they can be used with another manufacturers master or with a Trio *Motion Coordinator* and another manufacturer's module on the network.

### PROTOCOL SELECTION

CANopen is selected on the CAN I/O modules using the protocol (PR) switch on the module.

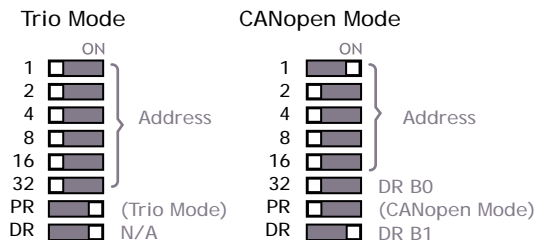

CANopen allows the use of different data rates, this is selected by setting the switches marked 32 and DR. Switch 32 sets bit 0 of the data rate and DR sets bit 1.

(DR B0)	DR (DR B1)	Data Rate
0	0	1Mb
0	1	500KB

1	0	250KB
1	1	125KB

## CONTROLLER SETUP

To use CANopen DS402 an initialisation program must be run that configures the network. Examples of this program can be found on the Trio website. Once The CANopen network is configured then you can use the CAN I/O with the standard **IN**, **OP**, **READ \_ OP**, **AIN** and **AOUT** \*commands as normal.

(\*Future software release)

## MODULE ADDRESSING

Each CAN I/O module becomes a node on the CANopen network. The address switches are used to assign a unique node number to the module.

## ERROR CODES

The power (PWR) and error (ERR) LEDs display the modules current state as per the tables below.

## LED STATE DEFINITIONS

LED state	Description
LED on	The LED constantly on.
LED off	The LED constantly off.
LED flickering	The LED flashes on and off with a frequency of approximately 10 Hz.
LED blinking	The LED flashes on and off with a frequency of approximately 2.5Hz: on for approximately 200ms followed by off for approximately 200ms.
LED single flash	The LED indicates one short flash.
LED double flash	The LED indicates a sequence of two short flashes.
LED triple flash	The LED indicate a sequence of three short flashes.
LED quadruple flash	The LED indicates a sequence of four short flashes.

## PWR LED ERROR CODE

The PWR LED is used as the 'CANopen run LED' as recommended by CANopen. Its state displays the following:

CAN Run LED	State	Description
Flickering	AutoBitrate/LSS	The auto-bitrate detection is in progress or LSS services are in progress (alternately flickering with error LED)

CAN Run LED	State	Description
Blinking	PRE-OPERATIONAL	The device is in state PRE-OPERATIONAL
Single flash	STOPPED	The device is in state STOPPED
Double flash	Reserved for further use	
Triple flash	Program/ Firmware download	A software download is running on the device
On	OPERATIONAL	The device is in state OPERATIONAL

### ERR LED ERROR CODE

The ERR LED is used as the ‘CANopen error LED’ as recommended by CANopen. Its state displays the following:

ERR LED	State	Description
Off	No error	The device is in working condition
Flickering	AutoBitrte/LSS	The auto-bitrate detection is in progress or LSS services are in progress (alternately flickering with run LED)
Blinking	Invalid Configuration	General configuration error
Single flash	Warning limit reached	At least one of the error counters of the CAN controller has reached or exceeded the warning level (too many error frames)
Double flash	Error control event	A guard event (NMT-slave or NMTmaster) or a heartbeat event (heartbeat consumer) has occurred
Triple flash	Sync error	The sync message has not been received within the configured communication cycle period time out.
Quadruple flash	Event-timer error	An expected PDO has not been received before the event-timer elapsed
On	Bus off	The CAN controller is bus off





INSTALLATION

5



# Installing Hardware

## Installing the MC464

### PACKAGING

The *Motion Coordinator MC464* is designed to be mounted on a DIN rail or, by use of optional mounting clips, it can be screwed to a backplate.

A cast metal chassis provides mechanical stability and a reliable earth connection to aid EMC immunity.

The rugged plastic case includes ventilation holes, top and bottom, and a removable cover to access the memory battery.

### EXPANDABLE DESIGN

System expansion is done by adding either single or double height modules. These are clipped to the MC464 and secured by a bolt which also acts as the earth connection between the MC464 and the module

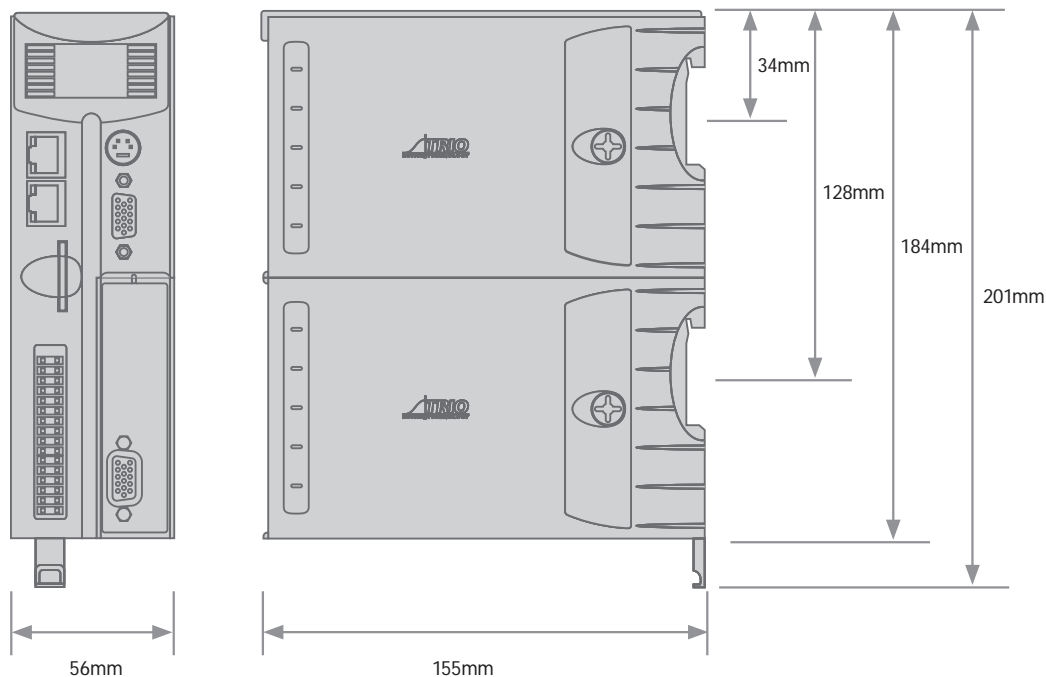

*MC464 Dimensions*

## ITEMS SUPPLIED WITH THE MC464

### CONNECTORS:

- 9 way D-Type plug
- Quick connect I/O connector (30 way)

### PANEL MOUNTING SET:

- 2 x Mounting bracket
- 1 x M3 x 10mm Countersunk screw
- 1 x M3 x 6mm Countersunk screw
- Quick start guide

## MOUNTING MC464

### GENERAL

The MC464 must be mounted vertically and should not be subjected to mechanical loading. Care must be taken to ensure that there is a free flow of air vertically around the MC464.

### DIN RAIL

Pull down the clip to allow the MC464 to be mounted on a single DIN rail. Push up the clip to lock it to the rail.

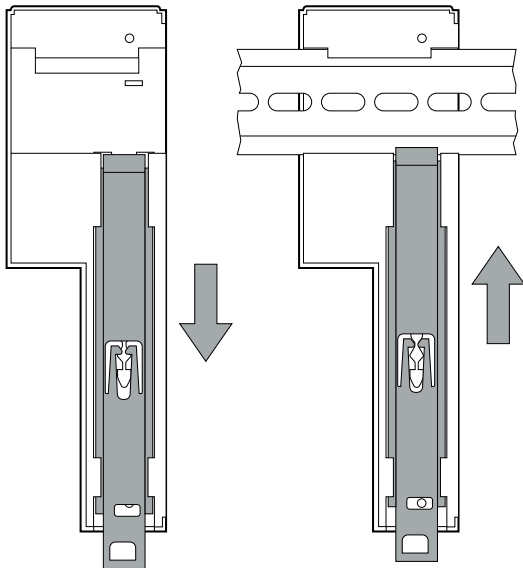

## Mounting Clips

Remove the 2 mounting clips from their packaging and insert one at the top rear of the case, by fitting the small tab into the rectangular slot and fix with the M3 x 6mm screw provided.

The second clip fits to the bottom of the case rear. Line up the DIN rail lever with the hole and slot in the metal chassis, fit the clip into the slot and fix it with the M3 x 10mm screw.

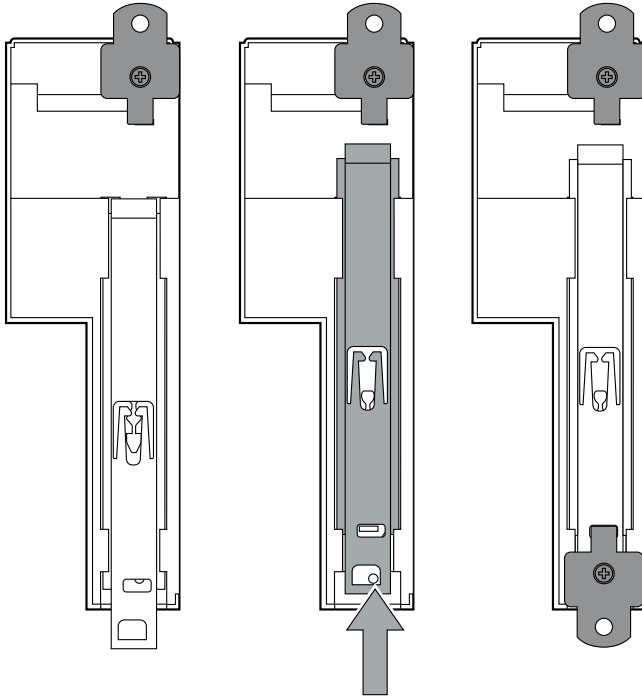

## ENVIRONMENTAL CONSIDERATIONS

The MC464 should not be handled whilst the 24 Volt power is connected.



**ENSURE THAT THE AREA AROUND THE VENTILATION HOLES AT THE TOP AND BOTTOM OF THE MC464 AND ANY ADDITIONAL MODULES ARE KEPT CLEAR. AVOID VIOLENT SHOCKS TO, OF VIBRATION OF, THE MC464, SYSTEM AND MODULES WHILST IN USE OR STORAGE.**

## IP RATING: IP 20

The MC464 and add-on modules are protected against solid objects intruding into the case and against humidity levels that do not induce condensation to occur.

# Installing the MC4N

## PACKAGING

The *Motion Coordinator MC4N* is designed to be mounted using the 2 mounting holes located on the back-plate.

A cast metal chassis provides superb mechanical stability and a dedicated earth connection point to aid EMC immunity.

The rugged plastic case has conveniently placed access ports for the I/O, encoder inputs, pulse outputs, EtherCAT port, Ethernet and serial connections. A slot is provided for the optional Micro SD card.

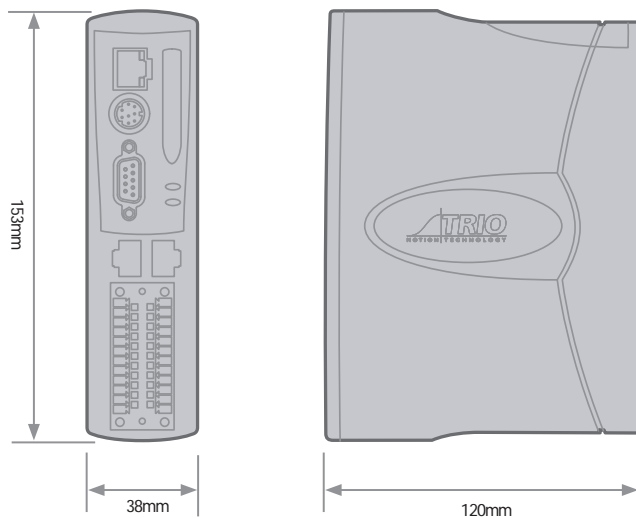

## ITEMS SUPPLIED WITH THE MC4N

### CONNECTORS

- 1 x 9 way D-Type plug and shell
- 1 x 5 way quick dis-connect screw terminal block
- 2 x 12 way quick dis-connect screw I/O connector
- Quick start guide

## MOUNTING MC4N

### GENERAL

The MC4N must be mounted vertically and should not be subjected to mechanical loading. Care must be taken to ensure that there is a free flow of air vertically around the MCN.

## SCREW MOUNTING

Drill and tap 2 mounting holes using the dimensions shown below. Use 2 x M4 pan-head screws, (not supplied) of a suitable length, to fix the MC4N to the panel. Screw the lower screw into the panel, leaving the screw head between 4 and 6 mm above the panel surface. Slide the MC4N down on to the screw and insert the upper screw. Tighten both screws.

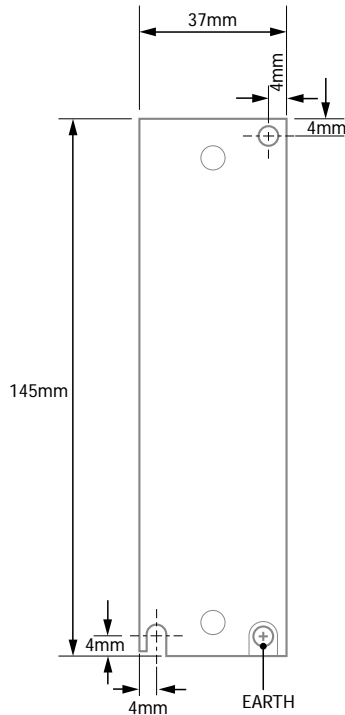

## ENVIRONMENTAL CONSIDERATIONS

The MC4N should not be handled whilst the 24 Volt power is connected.



**ENSURE THAT THE AREA AROUND THE TOP AND BOTTOM OF THE MC4N AND ANY ADDITIONAL I/O MODULES IS KEPT CLEAR. AVOID VIOLENT SHOCKS TO, OF VIBRATION OF, THE MC4N SYSTEM AND MODULES WHILST IN USE OR STORAGE.**

## IP RATING: IP 20

The MC4N is protected against solid objects intruding into the case and against humidity levels that do not induce condensation to occur.



# Instaling the MC405 / MC403

## PACKAGING

The *Motion Coordinator* MC405 / MC403 is designed to be mounted on a DIN rail or optionally, using the 3 mounting holes, it can be screwed to a back-plate.

A cast metal chassis provides superb mechanical stability and a dedicated earth connection point to aid EMC immunity.

The rugged plastic case has conveniently placed access ports for the I/O, encoder inputs, pulse outputs, Ethernet and serial connections. A slot is provided for the optional Micro SD card.

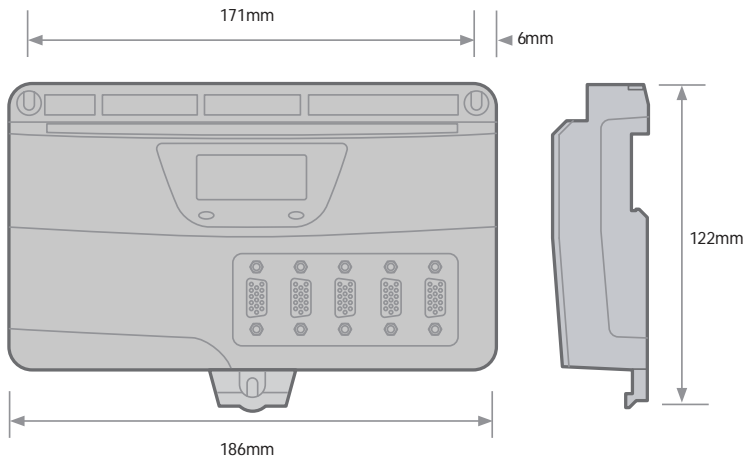

**MC405 Dimensions**

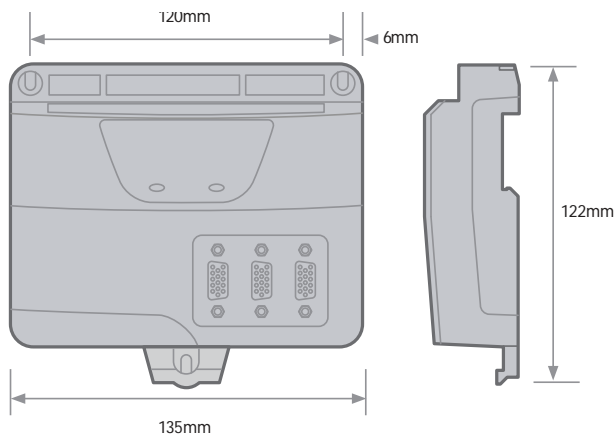

**MC403 Dimensions**

## ITEMS SUPPLIED WITH THE MC405 / MC403

### CONNECTORS

- 3 or 5 x 9 way D-Type plug and shell
- 1 x 5 way quick dis-connect screw terminal block
- 8 way and 14 way quick dis-connect screw terminal block (MC403)
- 2 x 10 way and 1 x 16 way quick dis-connect screw terminal block (MC405)
- Quick start guide

### MOUNTING MC405 / MC403

#### GENERAL

The MC405 / MC403 must be mounted vertically and should not be subjected to mechanical loading. Care must be taken to ensure that there is a free flow of air vertically around the MC405/MC403.

#### DIN RAIL

Pull down the clip to allow the MC405 / MC403 to be mounted on a single DIN rail. Release the spring-loaded clip to lock it to the rail.

#### SCREW MOUNTING

Drill and tap 3 mounting holes using the dimensions shown below. Use 3 x M4 pan-head screws, (not supplied) of a suitable length, to fix the MC405 / MC403 to the panel. Screw the upper 2 screws into the panel, leaving the screw head between 4 and 6 mm above the panel surface. Slide the MC405/MC403 up on to the 2 screws and insert the remaining lower screw. Tighten all 3 screws.

#### ENVIRONMENTAL CONSIDERATIONS

The MC403 / MC405 should not be handled whilst the 24 Volt power is connected.



**ENSURE THAT THE AREA AROUND THE TOP AND BOTTOM OF THE MC405 / MC403 AND ANY ADDITIONAL I/O MODULES IS KEPT CLEAR. AVOID VIOLENT SHOCKS TO, OF VIBRATION OF, THE MC405 / MC403, SYSTEM AND MODULES WHILST IN USE OR STORAGE.**

#### IP RATING: IP 20

The MC405 / MC403 are protected against solid objects intruding into the case and against humidity levels that do not induce condensation to occur.

# Installing the CAN I/O Modules

## PACKAGING

The CAN I/O modules are designed to be mounted on a DIN rail.

The rugged plastic case includes ventilation holes, top and bottom.

The dimensions are shown below.

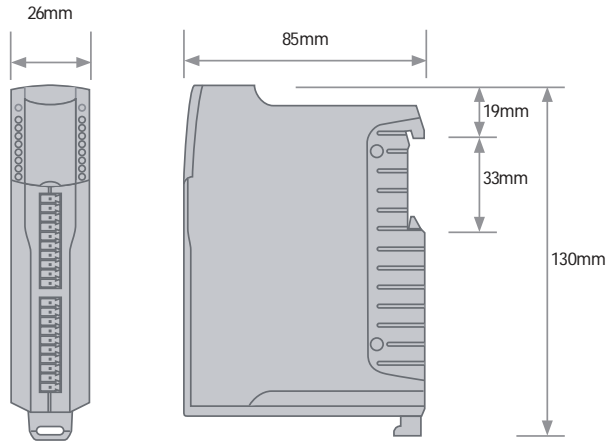

*CAN Module Dimensions*

## ITEMS SUPPLIED WITH CAN I/O MODULES

- 5 way CAN connector
- 2x 10 way I/O connectors
- 2x 120 Ohm terminating resistors
- Quick start guide

## MOUNTING CAN I/O MODULES

The CAN I/O modules should be mounted vertically and should not be subjected to mechanical loading. Care must be taken to ensure that there is a free flow of air vertically around the CAN I/O module.

To mount pull down the sprung loaded clip, slot over the DIN rail and release the clip to lock the module to the rail.

## ENVIRONMENTAL CONSIDERATIONS

The CAN I/O should not be handled whilst the 24 Volt power is connected.



ENSURE THAT THE AREA AROUND THE VENTILATION HOLES AT THE TOP AND BOTTOM OF THE CAN I/O ARE KEPT CLEAR. AVOID VIOLENT SHOCKS TO, OF VIBRATION OF, THE CAN I/O MODULES WHILST IN USE OR STORAGE.

## IP RATING: IP 20

### BUS WIRING

The CAN 16-I/O Modules and the *Motion Coordinator* are connected together on a CAN network running at 500kHz. The network is of a linear bus topology. That is the devices are daisy-chained together with spurs from the chain. The total length is allowed to be up to 100m, with drop lines or spurs of up to 6m in length. At both ends of the network, 120 Ohm terminating resistors are required between the CAN\_H and CAN\_L connections. The resistor should be 1/4 watt, 1% metal film.

The cable required consists of:

- Blue/White 24AWG data twisted pair
- Red/Black 22AWG DC power twisted pair
- Screen

A suitable type is Belden 3084A.

The CAN 16-I/O modules are powered from the network. The 24 Volts supply for the network must be externally connected. The *Motion Coordinator* does NOT provide the network power. In many installations the power supply for the *Motion Coordinator* will also provide the network power.



It is recommended that you use a separate power supply from that used to power the I/O to power the network as switching noise from the I/O devices may be carried into the network.

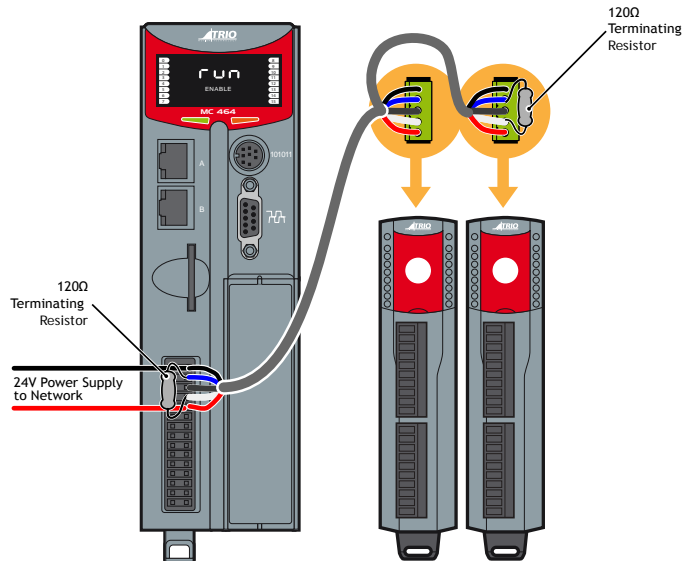



EMC

6



---

# EMC Considerations

Most pieces of electrical equipment will emit noise either by radiated emissions or conducted emissions along the connecting wires. This noise can cause interference with other equipment near-by which could lead to that equipment malfunctioning. These sort of problems can usually be avoided by careful wiring and following a few basic rules.

- Mount noise generators such as contactors, solenoid coils and relays as far away as possible from the *Motion Coordinator*.
- Where possible use solid-state contactors and relays.
- Fit suppressors across coils and contacts.
- Route heavy current power and motor cables away from signal and data cables.
- Ensure all the modules have a secure earth connection.
- Where screened cables are used terminate the screen with a 360 degree termination rather than a “pig-tail”. Connect both ends of the screen to earth. The screening should be continuous, even where the cable passes through a cabinet wall or connector.

These are just very general guidelines and for more specific advice on specific controllers, see the installation requirements later in this chapter. The consideration of EMC implications is more important than ever since the introduction of the EC EMC directive which makes it a legal requirement for the supplier of a product to the end customer to ensure that it does not cause interference with other equipment and that it is not itself susceptible to interference from other equipment.



## EMC Earth - MC464

Best EMC performance is obtained when the MC464 is attached to an earthed, unpainted metal panel using the two mounting clips. When screwed directly to the panel, the clips provide the required EMC earth connection.

If the MC464 is mounted on a DIN rail, then an additional EMC earth must be attached as shown below. Use a flat braided conductor, minimum width; 4mm. Connect to the earthed metal panel as close to the MC464 as possible. Do not use circular cross-section wire. Do not run the conductor to a central star point.

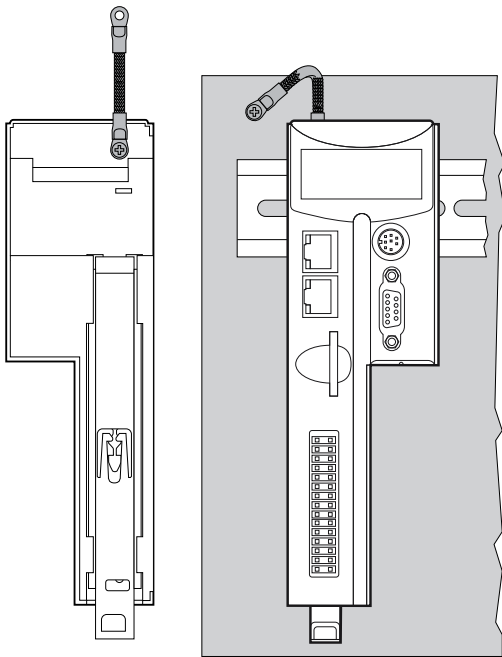

*MC464 Earth Braid shown rear (left) and front (right)*

## EMC Earth - MC4N

Best EMC performance is obtained when the MC4N is attached to an earthed, unpainted metal panel using two mounting screws. When screwed directly to the panel, the metal chassis provides the required EMC earth connection.

An additional EMC earth can be attached from the earth screw on the MC4N back plate as shown below. Use a flat braided conductor, minimum width 4mm. Connect to the earthed metal panel as close to the *Motion Coordinator* as possible. Do not use circular cross-section wire. Do not run the conductor to a central star point.

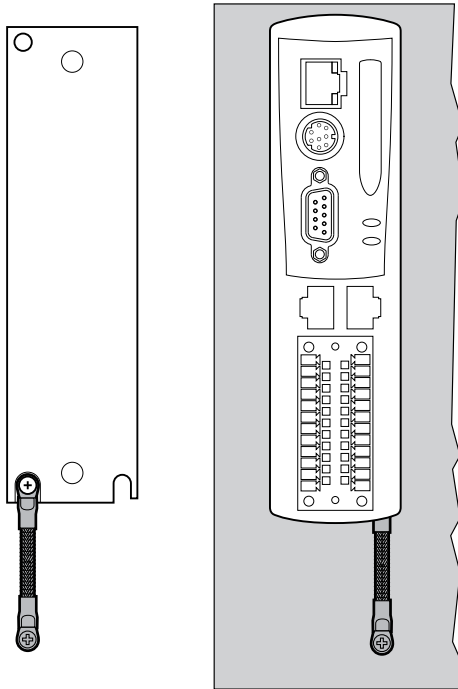

MC4N Earth Braid shown rear (left) and front (right)

## EMC Earth - MC405 / MC403

Best EMC performance is obtained when the MC405/MC403 is attached to an earthed, unpainted metal panel using three mounting screws. When screwed directly to the panel, the metal chassis provides the required EMC earth connection.

If the MC405/MC403 is mounted on a DIN rail, then an additional EMC earth must be attached as shown below. Use a flat braided conductor, minimum width 4mm. Connect to the earthed metal panel as close to the *Motion Coordinator* as possible. Do not use circular cross-section wire. Do not run the conductor to a central star point.

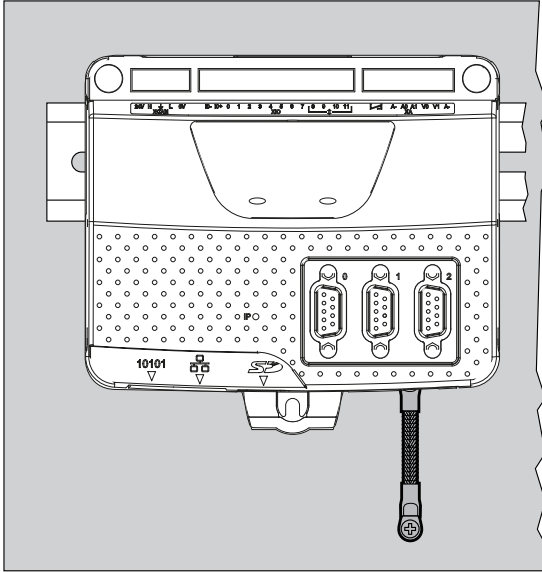

*MC403 Earth Braid. MC405 is Similar*

## EMC Earth - CAN I/O Modules

Best EMC performance is obtained when the CAN I/O modules have the screen of the CAN cable connected to the shield pin of the 5 way connector. Both ends of the CAN cable must be connected to an earth point on the back panel of the cabinet. The connection must be as close as possible to the last I/O module. Use a flat braided conductor, minimum width 4mm. Do not use circular cross-section wire. Do not run the conductor to a central star point.

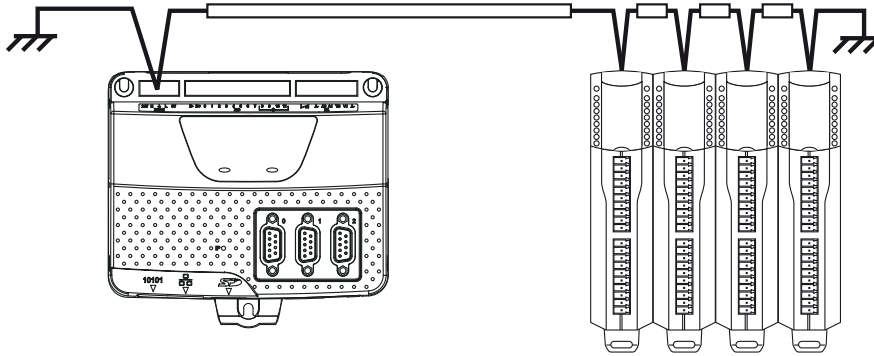

*MC403 and CAN I/O Modules*

## Cable Shields

All encoder cables must be terminated in the correct D-type plug, either 9 way or 15 way as required. For best EMC performance use a metal or metalised plastic cover for the D-type connector. Clamp the screen of the encoder cable where it enters the connector cover. Do not make a “pig-tail” connection from the screen to the plug cover. When plugging the D-type into the MC464, use the jack-screws to firmly attach the D-type plug to the socket on the MC464 or its axis module.

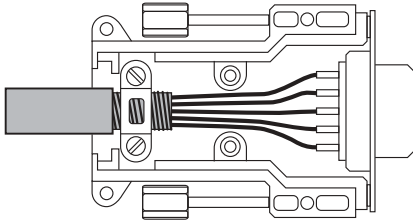

Both ends of the encoder cable’s screen must be connected using a 360 degree contact and not a pig-tail connection.

The 0V must be connected separately from the screen. Make sure that encoder cables are specified with one extra wire to carry the 0V.

SCREEN CONNECTED INTERNALLY  
TO METAL SHIELD



SCREEN CLAMPED TO EARTH

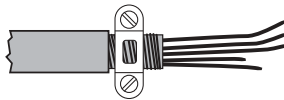

All serial cables must be terminated in an 8-pin mini-DIN connector. For best EMC performance, clamp the screen of the serial cable where it enters the connector cover. Do not make a “pig-tail” connection from the screen to the plug cover.



Both ends of the serial cable’s screen must be connected using a 360 degree contact and not a pig-tail connection.

The 0V must be connected separately from the screen. Make sure that serial cables are specified with one extra wire to carry the 0V. This applies to RS422/RS485 serial connections as well as RS232.

## Surge protection

This section applies to all devices including *Motion Coordinators*, CAN IO modules and HMIs. The surge protection described is to enable the system components to comply with EMC Generic Immunity for industrial environments standard IEC 61000-6-2:2005.

## SINGLE POWER SUPPLY

Where the device is supplied with 24V dc from one dedicated 24V power source and the connecting cable is less than 3 metres, there is no need for a separate surge protection device.

MC464

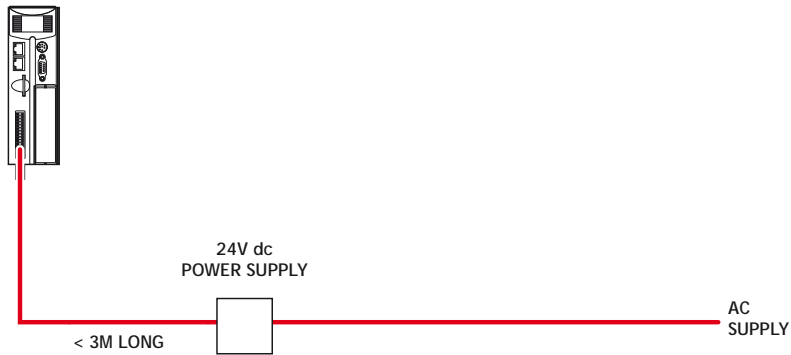

*Motion Coordinator with dedicated power source*

## DISTRIBUTED POWER SUPPLY

If the device is connected to a distributed power supply or the cable length between the power source and the device is longer than 3 metres, then a surge protection device must be fitted to comply with the CE EMC directive.

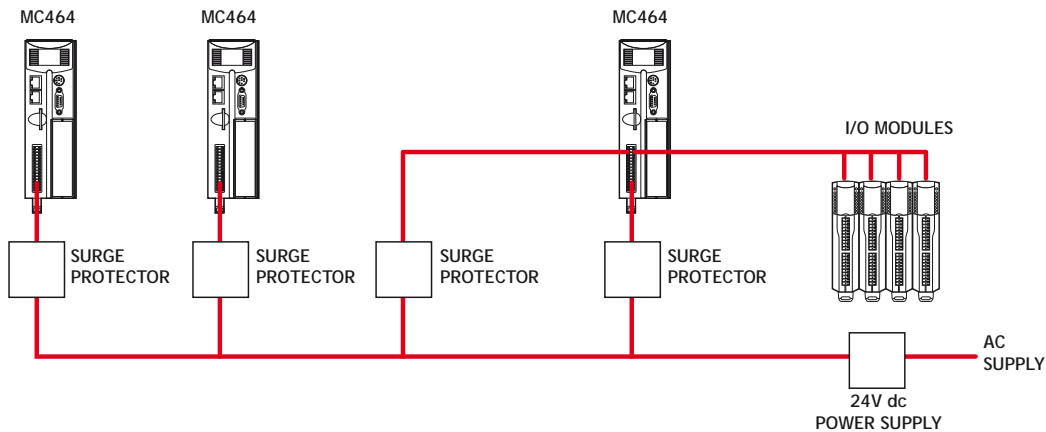

*Distributed power supply with surge protection*

## RECOMMENDED PROTECTION DEVICE

If a surge protector is required, a device conforming to the specification below must be installed as close as possible to the 24V power input requiring protection. In addition, the MC405 and MC403 require 2 x 220  $\mu$ F

electrolytic capacitors to complete the protection circuit.

<b>Protection device - Minimum specification</b>	
Operating Voltage	24V dc
Suppression Begins: Stage Two Stage Three	30V 35V
Max. Clamp Volts for transients on the line: Stage Two Stage Three	65V 77V
Surge Current (8/20mSec Pulse) + to - + to Earth - to Earth	9000A 4000A 4000A
Surge Energy (2mSec Pulse) + to - + to Earth - to Earth	94 Joules 44 Joules 44 Joules
Response Time	<5 nsec
Resistance to Earth: Max Over-Voltage Operating Voltage	0.01 $\Omega$ > 1 M $\Omega$

A suggested device is the DC Surge protector TSP-WG6-24VDC-10A-01 from Axiomatic. This protection device is easy to implement with Trio products and is DIN rail mountable. The DC Surge protector and Trio product must be connected to EARTH to make the protection effective.

## MC464 AND IO DEVICES

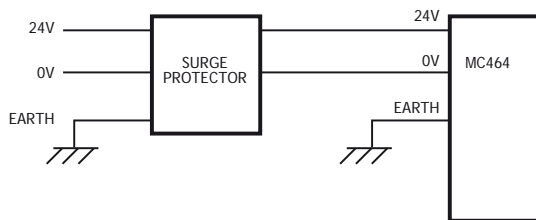

*Surge protection device*

## MC403/MC405

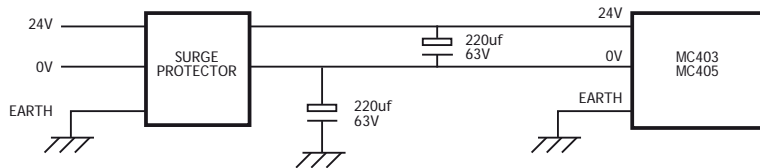

### Surge protection device



If the I/O power is from a different power source to the main device power, then the I/O power must also have a surge protector fitted.

## Background to EMC Directive

Since 1st January 1996 all suppliers of electrical equipment to end users must ensure that their product complies with the 89/336/EEC Electromagnetic Compatibility directive. The essential protection requirements of this directive are:

Equipment must be constructed to ensure that any electromagnetic disturbance it generates allows radio and telecommunications equipment and other apparatus to function as intended.

Equipment must be constructed with an inherent level of immunity to externally generated electromagnetic disturbances.

Suppliers of equipment that falls within the scope of this directive must show “due diligence” in ensuring compliance. Trio has achieved this by having products that it considers to be within the scope of the directive tested at an independent test house.

As products comply with the general protection requirements of the directive they can be marked with the CE mark to show compliance with this and any other relevant directives. At the time of writing this manual the only applicable directive is the EMC directive. The low voltage directive (LVD) which took effect from 1st January 1997 does not apply to current Trio products as they are all powered from 24V which is below the voltage range that the LVD applies to.

Just because a system is made up of CE marked products does not necessarily mean that the completed system is compliant. The components in the system must be connected together as specified by the manufacturer and even then it is possible for some interaction between different components to cause problems but obviously it is a step in the right direction if all components are CE marked.

### TESTING STANDARDS

For the purposes of testing, a typical system configuration was chosen because of the modular nature of the *Motion Coordinator* products. Full details of this and copies of test certificates can be supplied by Trio if required.

For each typical system configuration testing was carried out to the following standards:



### **EMISSIONS - BS EN61000-6-4 : 2007.**

The MC4 range of products conform to the Class A limits.

### **IMMUNITY - BS EN61000-6-2 : 2005.**

This standard sets limits for immunity in an industrial environment and is a far more rigorous test than part 1 of the standard.

## **REQUIREMENTS FOR EMC CONFORMANCE**

---



**WHEN THE TRIO PRODUCTS ARE TESTED THEY ARE WIRED IN A TYPICAL SYSTEM CONFIGURATION. THE WIRING PRACTICES USED IN THIS TEST SYSTEM MUST BE FOLLOWED TO ENSURE THE TRIO PRODUCTS ARE COMPLIANT WITHIN THE COMPLETED SYSTEM.**

---

A summary of the guidelines follows:

The MC464 modules must be earthed via the main chassis of the MC4 range using the lower panel mounting clip or an earth strap. This must be done even if DIN rail mounted.

If any I/O lines are not to be used they should be left unconnected rather than being taken to a terminal block, for example, as lengths of unterminated cable hanging from an I/O port can act as an antenna for noise.

Screened cables **MUST** be used for encoder, stepper and registration input feedback signals and for the demand voltage from the controller to the servo amplifier if relevant. The demand voltage wiring must be less than 1m long and preferably as short as possible. The screen must be connected to earth at both ends. Termination of the screen should be made in a 360 degree connection to a metallised connector shell. If the connection is to a screw terminal e.g. demand voltage or registration input the screen can be terminated with a short pig-tail to earth.

Ethernet cables should be shielded and as a minimum, meet the TIA Cat 5e requirements.

Connection to the serial ports should be made with a fully screened cable.

As well as following these guidelines, any installation instructions for other products in the system must be observed.

# INDEX



# Index

## A

Axis Positioning Functions ... 2-4, 2-13, 2-21

## B

Backplane Connector: Euro408 / 404 ... 2-40

Battery: MC464 ... 2-8

## C

Cable Shields ... 6-8

Communications: Euro408 / 404 ... 2-39

Communications: MC403 ... 2-20

Communications: MC405 ... 2-30

Communications: MC464 ... 2-4, 2-12

Connections to the Euro408 / 404 ... 2-40

Connections to the MC4N ... 2-13

Connections to the MC403 ... 2-21

Connections to the MC405 ... 2-31

Connections to the MC464 ... 2-5

Controller I/O mapping ... 4-14

## D

Display: Backlit: MC405 ... 2-37

Display: Backlit MC464 ... 2-9

Display: LED: MC403 ... 2-26

Display: MC4N ... 2-17

## E

EMC Conformance: requirements ... 6-12

EMC considerations ... 6-3

EMC Directive: background ... 6-11

EMC Earth - CAN I/O Modules ... 6-7

EMC Earth - MC4N ... 6-5

EMC Earth - MC405 / MC403 ... 6-6

EMC Earth - MC464 ... 6-4

EMC Testing Standards ... 6-11

Expansion Modules MC464

Anybus-CC Module (P875) ... 3-14

Assembly ... 3-3

EtherCAT Interface (P876) ... 3-13

Fitting ... 3-4

FlexAxis Interface (P874 / P879) ... 3-11

RTEX Interface (P871) ... 3-5

Sercos Interface (P872) ... 3-7

SLM Interface (P873) ... 3-9

## F

Feature Summary: Euro408 / 404 ... 2-47

Feature Summary: MC4N ... 2-19

Feature Summary: MC403 ... 2-27

Feature Summary: MC405 ... 2-38

Feature Summary: MC464 ... 2-11

## I

Input / Output Modules

CAN 8-Relay Module (P327) ... 4-12

CAN 16-Input Module (P318) ... 4-6

CAN 16-I/O Module (P319) ... 4-7

CAN 16-Output Module (P317) ... 4-4

CAN Analogue I/O Module (P326) ... 4-10

Installation of CAN I/O Modules ... 5-10

Installation of MC4N ... 5-6

Installation of MC405 / MC403 ... 5-8

Installation of MC464 ... 5-3

Introduction to the MC4xx Range ... 1-3

Introduction to Typical System Configuration ... 1-3

I/O Capability ... 2-3, 2-12, 2-20, 2-30

I/O Modules: General Description ... 4-3

## M

*Motion Coordinator Euro404 / 408* ... 2-39

*Motion Coordinator MC4N* ... 2-12

*Motion Coordinator MC403* ... 2-20

*Motion Coordinator MC405* ... 2-30

*Motion Coordinator MC464* ... 2-3

Mounting: CAN I/O Modules ... 5-10

Mounting: MC4N ... 5-6

Mounting: MC403 / MC405 ... 5-9

Mounting: MC464 ... 5-4

## N

Network Set-up : NC4N ... *2-18*

## P

Product Code: I/O Modules ... *4-3*

Protocol: CANopen DS401 ... *4-21*

Protocol: TrioCANv2 ... *4-15*

## R

Removable Storage: Euro404 /408 ... *2-39*

Removable Storage: MC4N ... *2-13*

Removable Storage: MC403 ... *2-21*

Removable Storage: MC405 ... *2-31*

Removable Storage: MC464 ... *2-4*

## S

Serial Connections: Euro408 / 404 ... *2-46*

Serial Connections: MC403 ... *2-22*

Serial Connections: MC405 ... *2-32*

Serial Connections: MC464 ... *2-5*

SLOT Numbers ... *3-3*

Surge protection ... *6-8*



