



(Please refer to the *Motion Coordinator* Technical Reference Manual for Full Details)

5-WAY CONNECTOR



This is a 5 way 3.5mm pitch connector. The connector is used both to provide the 24 Volt power to the MC403(-Z) and provide connections for I/O expansion via Trio's CAN I/O expanders. A 24V dc, Class 2 transformer or power source must be provided as this powers the unit.

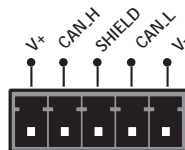

This 24 Volt input is internally isolated from the I/O 24 Volts and the +/-10V voltage outputs.

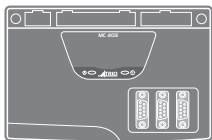
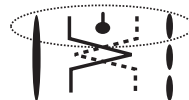

The 24V (V+) and 0V (V-) MUST be connected as they power the MC403(-Z). The MC403(-Z) is grounded via the metal chassis. A screw is provided on the chassis at the rear to allow an earth strap connection if needed. It MUST be installed on an unpainted metal plate or DIN rail which is connected to earth. The CAN connections are optional.

RJ45 CONNECTOR

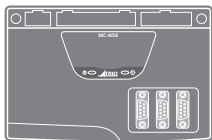

A standard Ethernet connector is provided for use as the primary programming interface. The Trio programming software, *Motion Perfect*, must be installed on a Windows based PC that is fitted with an Ethernet connection.

Ethernet cable must be CAT 5 or better.

SERIAL CONNECTIONS

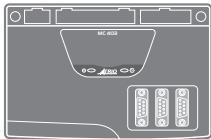

Serial Connector

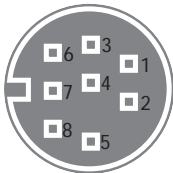

Pin	Function	Note
1	RS485 Data In A Rx+	Serial Port #2
2	RS485 Data In B Rx-	
3	RS232 Transmit	Serial Port #1
4	0V Serial	
5	RS232 Receive	Serial Port #1
6	5V	
7	RS485 Data Out Z Tx-	Serial Port #2
8	RS485 Data Out Y Tx+	

I/O CONNECTOR 1



24V Power / Inputs / I/O

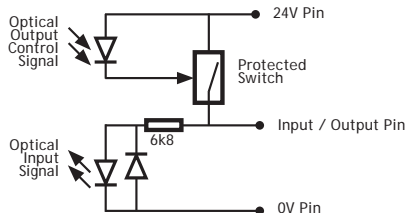
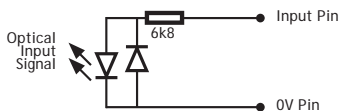

Any input, 0 - 5, may be mapped to any axis as a registration input.

I/O CONNECTOR 2

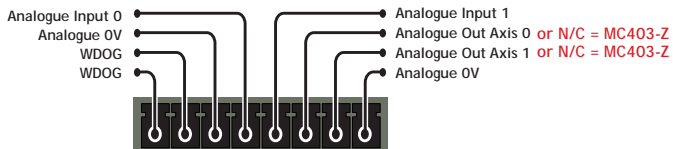
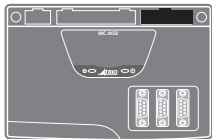

WDOG / Analogue Inputs / Outputs

I/O 24V must be applied to power the voltage outputs. (MC403 ONLY)

ANALOGUE INPUTS

AIN0: 0 TO 10V

AIN1: 0 TO 10V

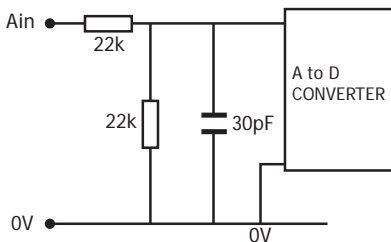

ANALOGUE OUTPUTS

AOUT 0 TO AOUT 1

Output: +/-10V at 5mA

Output impedance: 100 Ohms.

Common 0V return. Isolated from I/O & Encoders.

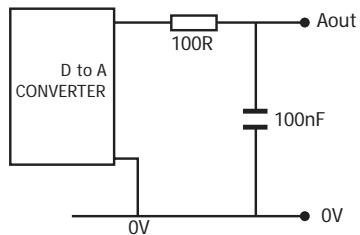

MC403 ONLY

AMPLIFIER ENABLE (WATCHDOG) RELAY OUTPUT

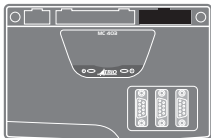

An internal relay is used to enable external amplifiers when the controller has powered up correctly and the system and application software are ready. The amplifier enable is a single pole solid state relay with a normally open “contact”. The enable relay contact will be open circuit if there is no power on the controller OR a following error exists on a servo axis OR the user program sets it open with the WDOG=OFF command.

ALL STEPPER AND SERVO AMPLIFIERS MUST BE INHIBITED WHEN THE AMPLIFIER ENABLE OUTPUT IS OPEN CIRCUIT

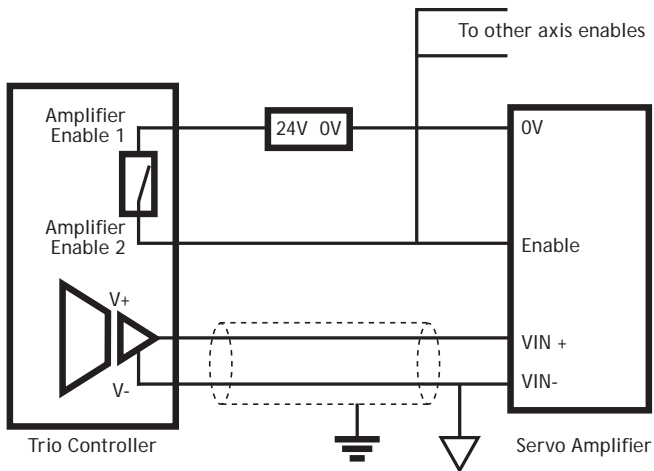

STEPPER OUTPUTS / ENCODER INPUTS

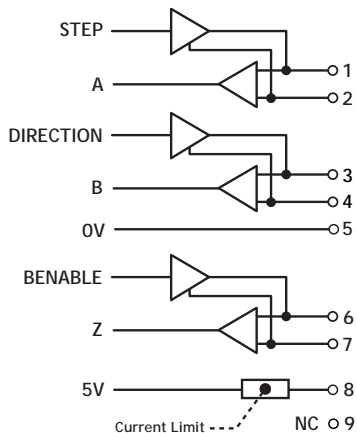
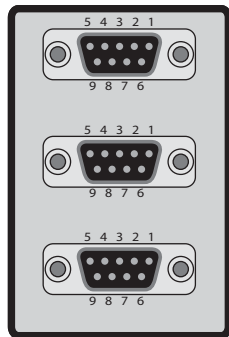
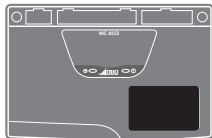

Pin	Servo Axis	Stepper Axis	Absolute Encoder
1	Enc. A	Step +	Clock
2	Enc. /A	Step -	/Clock
3	Enc. B	Direction +	-----
4	Enc. /B	Direction -	-----
5	0V	0V	0V Enc.
6	Enc. Z	Enable +	Data
7	Enc. /Z	Enable -	/Data
8	5V*	5V*	5V*
9	Not Connected	Not Connected	Not Connected

* Current limit is 150mA total, shared between all axes.

GROUNDING AND SHIELDING

Ensure that:

1. The shield screw is grounded as close to the MC403(-Z) as possible.
2. 0V, V- and E- connections are NOT used for terminating screens.
3. Pin 5 of Encoder/Stepper plug is connected to 0V on drive.
4. Encoder cable screen is clamped to 9 way D shell.
5. The MC403(-Z) 24V supply has common 0V with the drive(s).



When wiring MC403(-Z) Stepper outputs to a differential input stepper drive, use the 0V and shield connections shown for the encoder. The stepper drive must have its common 0V connected to the MC403(-Z) 24V return. (24V -)

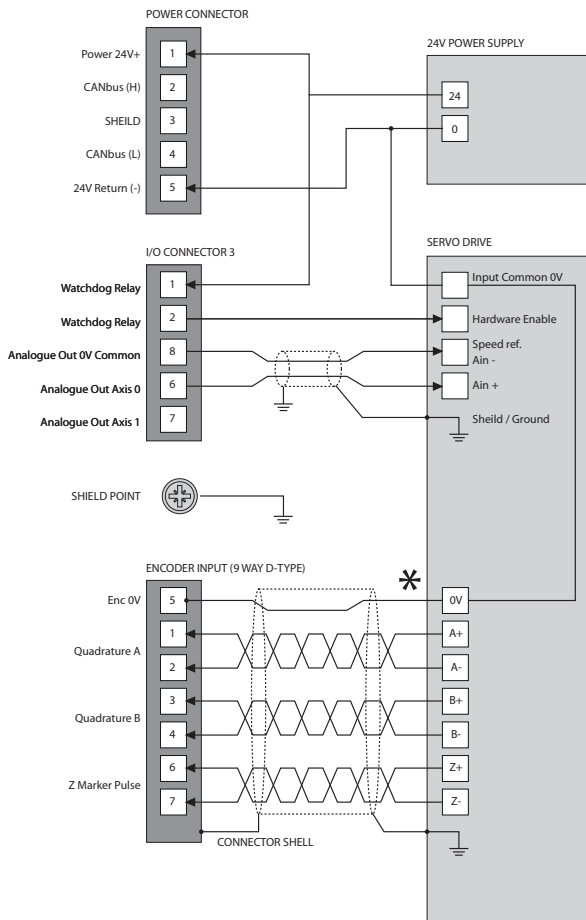

* Encoder input 0V MUST be connected to pin 5

STATUS LED'S

Display at start-up



green - ON



red - ON

Display with WDOG on



green - ON



red - OFF

Display Error



green - ON



red - FLASHING

IP ADDRESS RESET

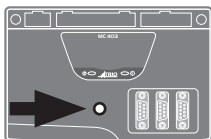

The factory default IP address is 192.168.0.250. This can be changed using the ETHERNET or IP_ADDRESS commands via *Motion Perfect*. To return to the factory IP address, hold the IP address reset switch in while powering up.

Good quality screened cables should be used for the serial ports. The serial ports and CANbus port are not galvanically isolated, therefore the 0V return MUST be connected to all peripheral devices. In addition, bond together the 0V (24V return) terminals of all system components so as to minimise current flowing in the serial cables.

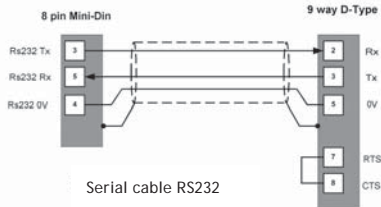
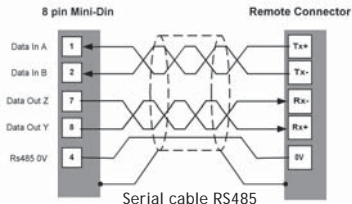

Trio Motion Technology Ltd.

Trio Motion Technology LLC

Trio Shanghai

Trio India

Website: www.triomotion.com