

# MP5S/MP5Y/MP5W/MP5M Series

## High-performance, Digital Pulse Meter

### ■ Features

- 13 kinds of various operation modes :  
Revolution, speed, frequency, absolute ratio, passing time, error ratio, cycle, density, passing speed, error, time width, length measurement, time difference, interval, multiplication(MP5M Series have 11 operation modes)
- Various output function :  
Relay output, NPN/PNP open collector output, low speed serial output, BCD output, PV transmission, RS485 communication output
- Various functions :  
Prescale function, data monitoring function, hysteresis function, peak value monitoring function, monitoring delay function, auto zero time setting function, lock setting function, display period delay function
- Max. display range : -19999 to 99999(MP5M : 0 to 99999)
- Various display units : rpm, rps, Hz, kHz, sec, min, m, mm, mm/ s, m/s, m/min, m/h, *l/s*, *l/min*, *l/h*, %, counts, etc.
- Selectable voltage input(PNP) or no voltage input(NPN)
- 50kHz high speed response



⚠ Please read "Caution for your safety" in operation manual before using.



### ■ Ordering information



MP 5 S - 4 N

|              |   | Main output(Comparative value output)                       | Sub output(Display value output)    |                                  |
|--------------|---|---|-------------------------------------|----------------------------------|
| S Type       | N   | Indicator   | —                                   |                                  |
|              | Y Type  | N   | Indicator                           | —                                |
|              |   | 1   | NPN open collector quintuple output | —                                |
|              |   | 2   | PNP open collector quintuple output | —                                |
|              |   | 3   | Indicator                           | BCD Dynamic                      |
|              |   | 4   | Indicator                           | PV transmission output(DC4-20mA) |
|              | W Type  | 5   | Indicator                           | RS485 communication output       |
|              |   | N   | Indicator                           | —                                |
|              |   | A   | Five relay(HH, H, GO, L, LL)        | —                                |
|              |   | 1   | Triple relay(H, GO, L)              | —                                |
|              |   | 2   | NPN open collector quintuple output | BCD dynamic                      |
|              |   | 3   | PNP open collector quintuple output | BCD dynamic                      |
|              |   | 4   | NPN open collector quintuple output | PV transmission output(DC4-20mA) |
| 5            |   | PNP open collector quintuple output                         | PV transmission output(DC4-20mA)    |                                  |
| 6            |   | NPN open collector quintuple output                         | Low speed serial output             |                                  |
| M Type       | 7   | PNP open collector quintuple output                         | Low speed serial output             |                                  |
|              | 8   | NPN open collector quintuple output                         | RS485 communication output          |                                  |
|              | 9   | PNP open collector quintuple output                         | RS485 communication output          |                                  |
|              | N   | Indicator   | —                                   |                                  |
|              | 1   | Relay single(High-limit) output + NPN open collector output | —                                   |                                  |
| 2            | Relay dual(High/Low-limit) output + NPN open collector output | —   |                                     |                                  |
| Power supply |   | 2   | 24VDC(Only for MP5Y-24)             |                                  |
|              |   | 4   | 100-240VAC 50/60Hz                  |                                  |
| Size         |   | S   | DIN W48×H48mm                       |                                  |
|              |   | Y   | DIN W72×H36mm                       |                                  |
|              |   | W   | DIN W96×H48mm                       |                                  |
|              |   | M   | DIN W72×H72mm                       |                                  |
| Digit        |   | 5   | 99999(5digit)                       |                                  |
| Series       |   | MP  | Pulse meter                         |                                  |

※PNP open collector output : Option

# Pulse(Rate) Meter

## ■ Specifications(MP5S/MP5Y/MP5W Series)

| Series                       | MP5S-4N   | MP5Y-24   | MP5Y-4□   | MP5W-4□   |
|------------------------------|---|---|---|---|
| Display method               | 7 Segment LED display(Zero blanking type)   |   |   |   |
| Character size               | W4 × H8mm   | W6.8 × H13.8mm  |   |   |
| Max. indication              | -19999 to 99999   |   |   |   |
| Power supply                 | 100-240VAC 50/60Hz  | 24VDC   | 100-240VAC 50/60Hz  | 100-240VAC 50/60Hz  |
| Allowable operation voltage  | 90 to 110%  |   |   |   |
| Power consumption            | Max. 7.5VA  | Max. 6W   | Max. 7VA  | Max. 6VA  |
| Power for external sensor    | 12VDC ±10%, 80mA  |   |   |   |
| Input frequency              | <ul style="list-style-type: none"> <li>• Solid-state input : Max. 50kHz(Pulse width : Each over 10μs)</li> <li>• Contact input : Max. 45Hz(Pulse width : Over 11ms)</li> </ul>  |   |   |   |
| Input level                  | [Voltage input] High : 4.5-24VDC, Low : 0-1.0VDC, Input impedance : 4.5kΩ<br>[No-voltage input] Impedance at short-circuit : Max. 300Ω, Residual voltage : Max. 1V<br>Impedance at open-circuit : Min. 100kΩ  |   |   |   |
| Measuring range              | <ul style="list-style-type: none"> <li>• Mode F1, F2, F7, F8, F9, F10 : 0.0005Hz to 50kHz</li> <li>• Mode F3 : 0.02s to 3,200s</li> <li>• Mode F4, F5, F6 : 0.01s to 3,200s</li> <li>• Mode F11, F12, F13 : 0 to 4 × 10 Count</li> </ul>  |   |   |   |
| Measuring accuracy (23 ±5°C) | <ul style="list-style-type: none"> <li>• Mode F1, F2, F7, F8, F9, F10 : F.S. ±0.05% rdg ±1digit</li> <li>• Mode F3, F4, F5, F6 : F.S. ±0.01% rdg ±1digit</li> </ul>   |   |   |   |
| Display period               | 0.05 / 0.5 / 1 / 2 / 4 / 8sec.(It is same with period of output update.)  |   |   |   |
| Operation mode               | Number of revolution/Speed/Frequency(F1), Passing speed(F2), Cycle(F3), Passing time(F4), Time width(F5), Time deference(F6), Absolute ratio(F7), Error ratio(F8), Density(F9), Error(F10), Length measurement(F11), Interval(F12), Multiplication(F13)<br>※Refer to the M-20 to 23 for the operation mode. |   |   |   |
| Prescale function            | Direct input method(0.0001×10 <sup>-9</sup> to 9.9999×10 <sup>9</sup> )   |   |   |   |
| Hysteresis <sup>*1</sup>     | 0 to 9999   |   |   |   |
| Other functions              | <ul style="list-style-type: none"> <li>• Lock setting function</li> <li>• Auto-Zero time setting function</li> <li>• Time unit selection function</li> <li>• Peak value monitoring function</li> <li>• Memory protection function (Mode F13 applied only)</li> </ul>  |   |   |   |
| Main output                  | Triple relay  | —   | —   | 250VAC 3A resistive load 3a   |
|                              | Quintuple relay   |   |   |   |
|                              | NPN Open collector (Quintuple)  |   |   |   |
|                              | PNP Open collector (Quintuple)  |   |   |   |
| Sub output                   | BCD Dynamic   | —   | NPN Open collector 12-24VDC 30mA Max.   | NPN Open collector 12-24VDC 20mA max.   |
|                              | Low speed serial output   | —   | —   | —   |
|                              | PV transmission   | —   | DC4-20mA Load 600Ω Max. (Response time : Max. 800ms)                                      | DC4-20mA Load 600Ω Max.   |
|                              | RS485 communication   | —   | 31 channels, Mutual direction communication function                                      |   |
| Memory protection            | Non-volatile memory(Input : Min. 100,000 times)   |   |   |   |
| Insulation resistance        | Min. 100MΩ(at 500VDC megger) Between charge part and non-charge part  |   |   |   |
| Dielectric strength          | 2000VAC 60Hz 1minute(Between terminals of AC power and case, Between terminals of AC power and measuring input terminals)   |   |   |   |
| Impulse noise strength       | ±2000VAC R-phase, S-phase the square wave noise(pulse width : 1μs) by the noise simulator, repeat frequency 60Hz  |   |   |   |
| Vibration                    | Mechanical  | 0.75mm amplitude at frequency of 10 to 55Hz(for 1 min.) in each of X, Y, Z directions for 2 hour    |   |   |
|                              | Malfunction   | 0.5mm amplitude at frequency of 10 to 55Hz(for 1 min.) in each of X, Y, Z directions for 10 minutes |   |   |
| Shock                        | Mechanical  | 300m/s <sup>2</sup> (approx. 30G) in each of X, Y, Z directions for 3 times                         |   |   |
|                              | Malfunction   | 100m/s <sup>2</sup> (approx. 10G) in each of X, Y, Z directions for 3 times                         |   |   |
| Relay life cycle             | Malfunction   | —   | Min. 10,000,000 operations  |   |
|                              | Mechanical  | —   | Min. 100,000 operations(250VAC 3A load current)   |   |
| Environment                  | Ambient temperature   | -10 to 50°C, storage : -20 to 60°C  |   |   |
|                              | Ambient humidity  | 35 to 85%RH, storage : 35 to 85%RH  |   |   |
| Weight                       | Approx. 199.5g(approx. 141.5g)  | Approx. 209g(approx. 117g)  |   | Approx. 301.5g(approx. 177g)  |
| Approval                     | CE  us   | —   | CE  us | CE  us |

※1: The hysteresis setting range is changed by the setting position of decimal point. (Refer to M-26 for hysteresis function.)

※2: Data bank switching function is in MP5W Series only.

※3: The weight with packaging and the weight in parentheses is only unit weight.

|     |                                  |
|-----|----------------------------------|
| (A) | Photo electric sensor            |
| (B) | Fiber optic sensor               |
| (C) | Door/Area sensor                 |
| (D) | Proximity sensor                 |
| (E) | Pressure sensor                  |
| (F) | Rotary encoder                   |
| (G) | Connector/Socket                 |
| (H) | Temp. controller                 |
| (I) | SSR/Power controller             |
| (J) | Counter                          |
| (K) | Timer                            |
| (L) | Panel meter                      |
| (M) | Tacho/Speed/ Pulse meter         |
| (N) | Display unit                     |
| (O) | Sensor controller                |
| (P) | Switching mode power supply      |
| (Q) | Stepper motor& Driver&Controller |
| (R) | Graphic/ Logic panel             |
| (S) | Field network device             |
| (T) | Software                         |
| (U) | Other                            |

# MP5S/MP5Y/MP5W/MP5M Series

## Specifications(MP5M Series)

| Model                                  | MP5M-4N  | MP5M-41  | MP5M-42   |
|--|--|--|---|
| Indicator                              |  | High-limit setting type  | High/Low-limit setting type   |
| Display method                         | 7 Segment LED display(Zero blanking), Character size : W4 X H8mm   |  |   |
| Max. indication                        | 0.0001 to 99999  |  |   |
| Power supply                           | 100-240VAC 50/60Hz   |  |   |
| Allowable operation voltage            | 90 to 110%   |  |   |
| Power consumption                      | Approx. 7.5VA(240VAC)  | Approx. 8VA(240VAC)  |   |
| Power for external sensor              | 12VDC $\pm 10\%$ , 80mA  |  |   |
| Input frequency                        | <ul style="list-style-type: none"> <li>Solid-state input : Max. 50kHz(pulse width : over 10<math>\mu</math>s)</li> <li>Contact input : Max. 45Hz(pulse width:over 11ms)</li> </ul>   |  |   |
| Input level                            | [Voltage input] High : 4.5-24VDC, Low : 0-1.0VDC, Input impedance : 4.5k $\Omega$<br>[No-voltage input] Impedance at short-circuit : Max. 300 $\Omega$ , Residual voltage : Max. 1V<br>Impedance at open-circuit : Min. 100k $\Omega$  |  |   |
| Measuring range                        | <ul style="list-style-type: none"> <li>Mode F1, F2, F7, F8 : 0.0005Hz to 50kHz</li> <li>Mode F4, F5, F6 : 0.01s to 3,200s</li> </ul>   | <ul style="list-style-type: none"> <li>Mode F3 : 0.02s to 3,200s</li> <li>Mode F9, F10, F11 : 0 to 4 <math>\times 10^9</math> Count</li> </ul>   |   |
| Measuring accuracy(23 $\pm 5^\circ$ C) | <ul style="list-style-type: none"> <li>Mode F1, F2, F7, F8 : F.S. <math>\pm 0.05\%</math> rdg <math>\pm 1</math>digit</li> <li>Mode F3, F4, F5, F6 : F.S. <math>\pm 0.01\%</math> rdg <math>\pm 1</math>digit</li> </ul>   |  |   |
| Display period                         | 0.05 / 0.5 / 1 / 2 / 4 / 8sec.(It is same with period of output update.)   |  |   |
| Operation mode                         | Number of revolution/Speed/Frequency(F1), Passing speed(F2), Cycle(F3), Passing time(F4),<br>Time width(F5), Time difference(F6), Absolute ratio(F7), Density(F8), Length measurement(F9),<br>Interval(F10), Multiplication(F11) <span style="float:right">※Refer to M-20 to 23 for operation mode.</span> |  |   |
| Prescale function                      | Direct input method(0.0001 $\times 10^{-9}$ to 9.9999 $\times 10^9$ )  |  |   |
| Hysteresis                             | —  | 0 to 9999  |   |
| Other function                         | <ul style="list-style-type: none"> <li>Lock setting function</li> <li>Auto-Zero time setting function</li> <li>Time unit selection function</li> <li>Peak value monitoring function</li> <li>Memory protection function (Mode F11 applied only)</li> </ul>   | <ul style="list-style-type: none"> <li>Lock setting function</li> <li>Monitoring delay function</li> <li>Auto-Zero time setting function</li> <li>Time unit selection function</li> <li>Peak value monitoring function</li> <li>Memory protection function (Mode F11 applied only)</li> <li>High-limit output function(H)</li> </ul> | <ul style="list-style-type: none"> <li>Lock setting function</li> <li>Monitoring delay function</li> <li>Auto-Zero time setting function</li> <li>Time unit selection function</li> <li>Peak value monitoring function</li> <li>Memory protection function (Mode F11 applied only)</li> <li>Comparative output function(H, L)</li> <li>Output mode selection function (S, H, L, B, I, F)</li> <li>Deviation memory function (F output mode applied only)</li> </ul> |
| Main output                            | Relay<br>NPN Open Collector  | 250VAC 3A resistive load 1c<br>30VDC 100mA Max.  | 250VAC 3A resistive load 1a $\times 2$<br>30VDC 100mA Max. $\times 2$   |
| Memory protection                      | Non-volatile memory(Input : Min. 100,000 operations)   |  |   |
| Approval                               |   |  |   |
| Unit weight                            | Approx. 275g   | Approx. 310g   | Approx. 330g  |

※MP5S, MP5Y, MP5W have same function.

※Environment resistance is rated at no freezing or condensation.

## Connections

### MP5M Series

#### MP5M-4N(Indicator)

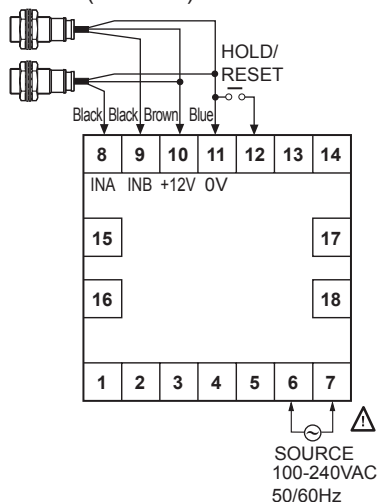

#### MP5M-41(High-limit setting type)

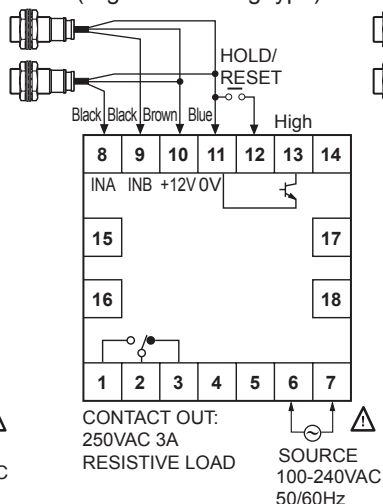

#### MP5M-42(High/Low-limit setting type)

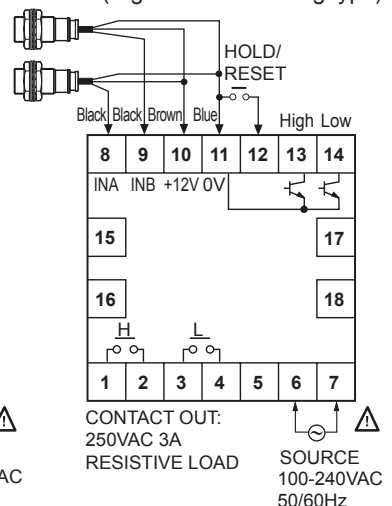

# Pulse(Rate) Meter

## ■ Connections

### ◎ MP5S Series

#### ● MP5S-4N(Indicator)

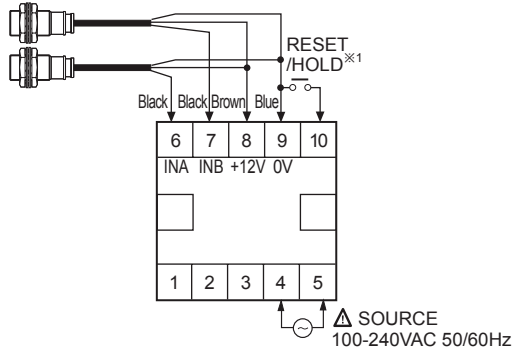

※1: It is used for RESET terminal when an operation mode is F13.(Refer to the M-20 to 23 for operation mode.)

### ◎ MP5Y Series

#### ● MP5Y-□N(Indicator)

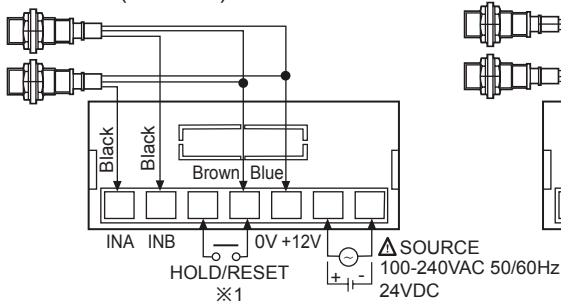

#### ● MP5Y-□4 to □5(Main/Sub output type)

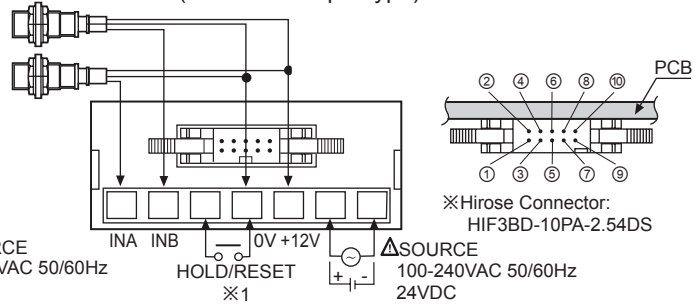

※Hirose Connector: HIF3BD-10PA-2.54DS

※1: It is used for RESET terminal when an operation mode is F13. (Refer to M-20 to 23 for operation mode.)

### ● Main output(Connector)

#### ● MP5Y-□1(NPN open collector output)

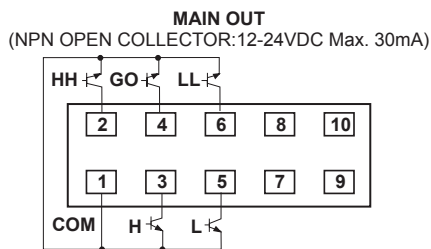

#### ● MP5Y-□2(PNP open collector output)

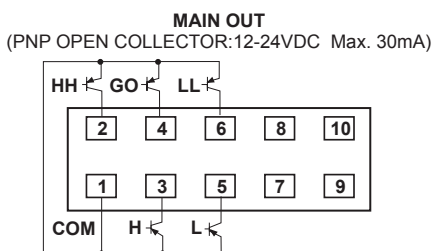

### ● Sub output(Connector)

#### ● MP5Y-□3(BCD dynamic output)

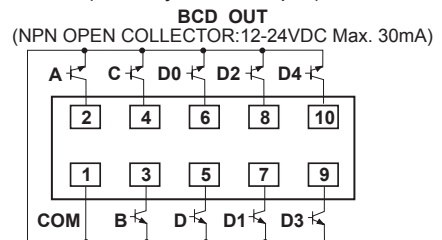

#### ● MP5Y-□4(PV transmission output)

DC4-20mA  
Load 600Ω Max.

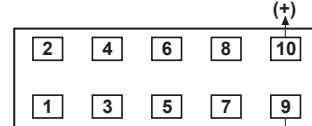

#### ● MP5Y-□5(RS485 communication output)

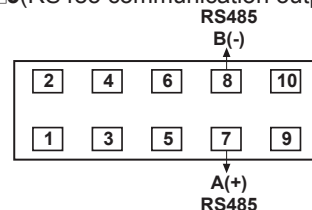

※Main output type & sub output type : Customizable

|     |                                  |
|-----|----------------------------------|
| (A) | Photo electric sensor            |
| (B) | Fiber optic sensor               |
| (C) | Door/Area sensor                 |
| (D) | Proximity sensor                 |
| (E) | Pressure sensor                  |
| (F) | Rotary encoder                   |
| (G) | Connector/Socket                 |
| (H) | Temp. controller                 |
| (I) | SSR/ Power controller            |
| (J) | Counter                          |
| (K) | Timer                            |
| (L) | Panel meter                      |
| (M) | Tacho/ Speed/ Pulse meter        |
| (N) | Display unit                     |
| (O) | Sensor controller                |
| (P) | Switching mode power supply      |
| (Q) | Stepper motor& Driver&Controller |
| (R) | Graphic/ Logic panel             |
| (S) | Field network device             |
| (T) | Software                         |
| (U) | Other                            |

# MP5S/MP5Y/MP5W/MP5M Series

## ◎ MP5W Series

### ● MP5W-□N(Indicator)

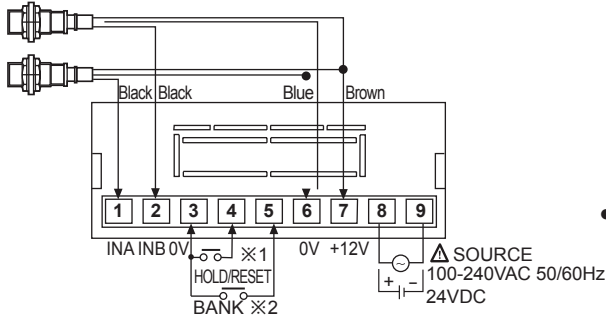

- ※1: It is used for RESET terminal when an operation mode is F13. (Refer to the M-20 to 23)
- ※2: Refer to M-26 for BANK function.
- ※Main output type & sub output type : option

### ● MP5W-□A(Five relay output)

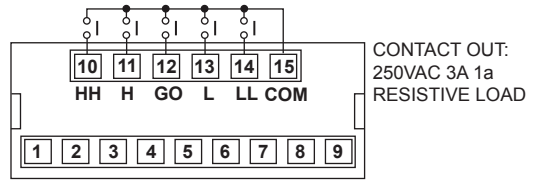

### ● MP5W-□1(Triple relay output)

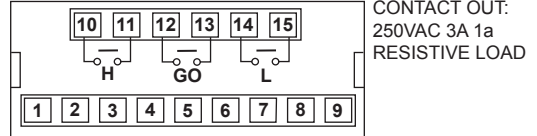

### ● Main output+Sub output(Connector)

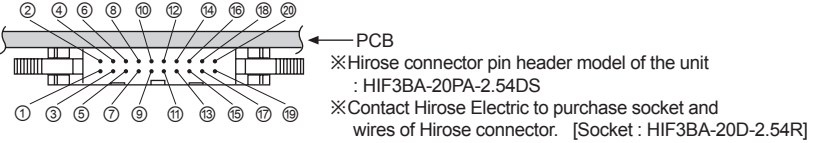
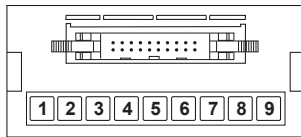

### ● MP5W-□2/ MP5W-□3(NPN/PNP open collector output + BCD output)

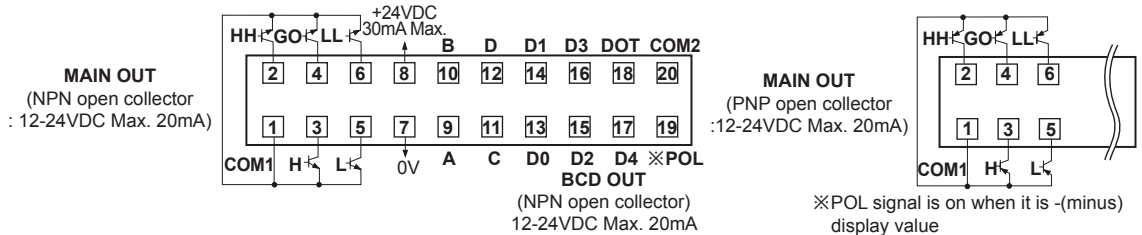

### ● MP5W-□4/ MP5W-□5(NPN/PNP open collector output + PV transmission output(DC4-20mA) output)

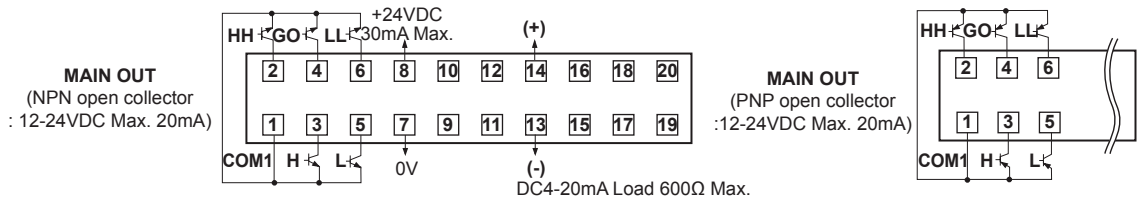

### ● MP5W-□6/ MP5W-□7(NPN/PNP open collector output + Low speed serial output)

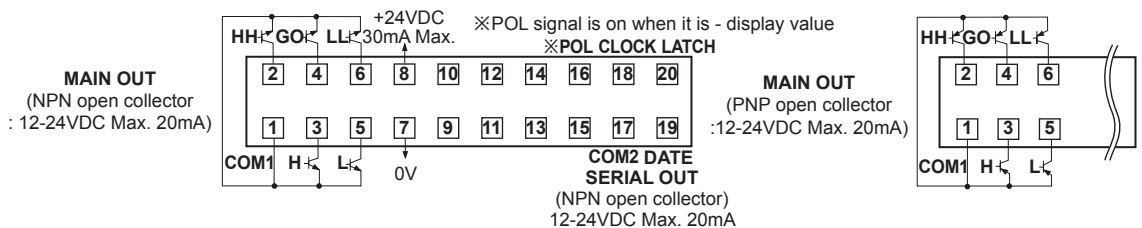

### ● MP5W-□8/ MP5W-□9(NPN/PNP open collector output + RS485 communication output)

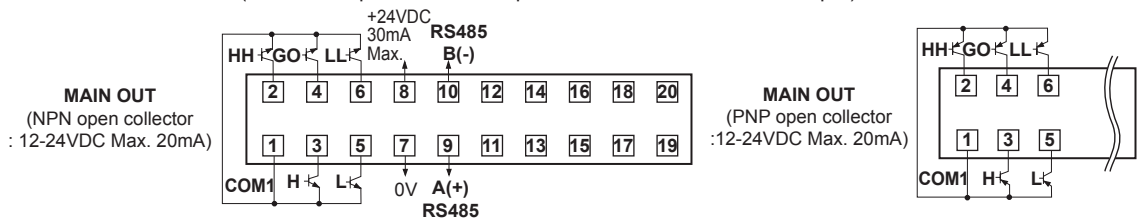

# Pulse(Rate) Meter

## ■ Dimensions

(unit: mm)

- MP5S Series
- Bracket

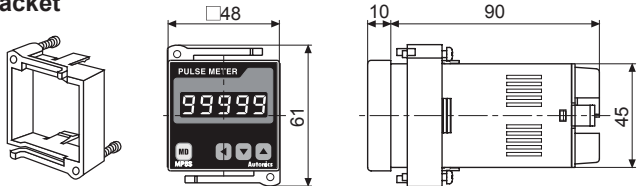

### ● Panel cut-out

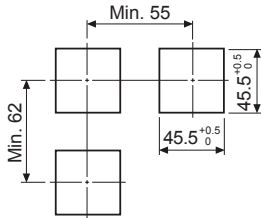

- MP5Y Series

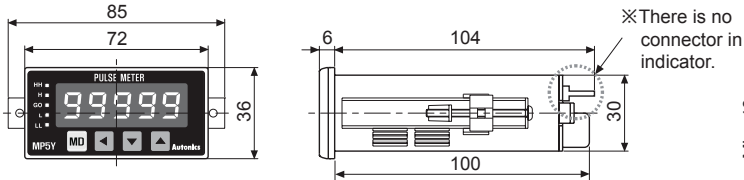

### ● Panel cut-out

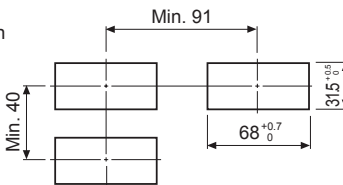

※Hirose connector : HIF3BD-10PA-2.54DS

- MP5W Series

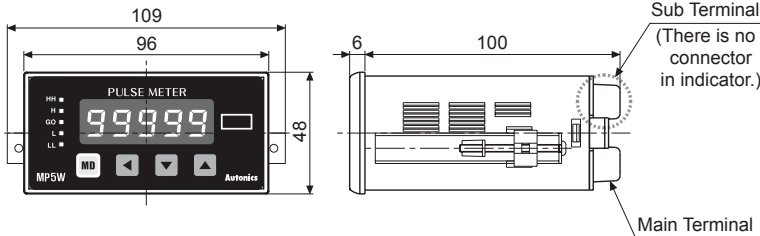

### ● Panel cut-out

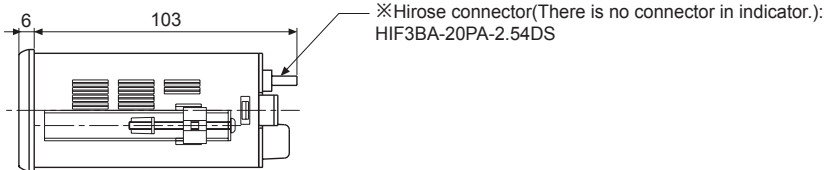
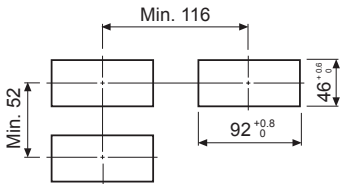

- MP5M Series

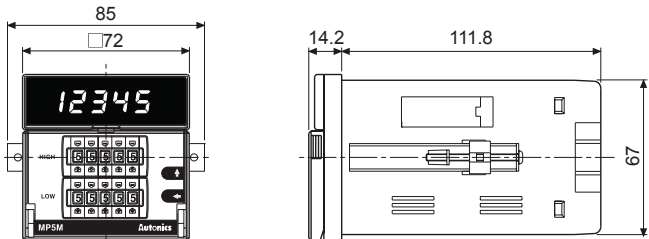

### ● Panel cut-out

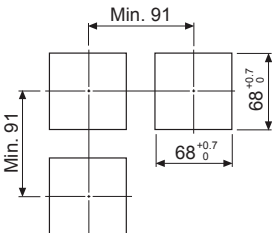

|     |                                  |
|-----|----------------------------------|
| (A) | Photo electric sensor            |
| (B) | Fiber optic sensor               |
| (C) | Door/Area sensor                 |
| (D) | Proximity sensor                 |
| (E) | Pressure sensor                  |
| (F) | Rotary encoder                   |
| (G) | Connector/ Socket                |
| (H) | Temp. controller                 |
| (I) | SSR/ Power controller            |
| (J) | Counter                          |
| (K) | Timer                            |
| (L) | Panel meter                      |
| (M) | Tacho/ Speed/ Pulse meter        |
| (N) | Display unit                     |
| (O) | Sensor controller                |
| (P) | Switching mode power supply      |
| (Q) | Stepper motor& Driver&Controller |
| (R) | Graphic/ Logic panel             |
| (S) | Field network device             |
| (T) | Software                         |
| (U) | Other                            |

# MP5S/MP5Y/MP5W/MP5M Series

## Input specifications

### Input signal

#### Solid-state input

- Input frequency : **50kHz Max.**  
Standard duty ratio of input signal is 1:1,  
ON/OFF pulse width should be over 10 $\mu$ s.
- Input voltage level : High  $\rightarrow$  4.5-24VDC, Low  $\rightarrow$  0-1.0VDC

#### Relay contact input

- Input frequency : **45Hz Max.**  
ON/OFF pulse width should be over 11ms.
- Relay contact specification : Please use a relay contact that can carry the load current(Min. 12VDC 2mA).

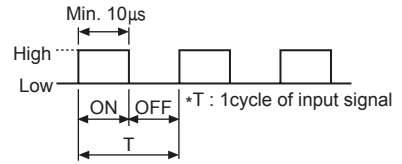

### Input type

MP5 has NPN input and PNP input and it is able to select in Parameter group 1.

#### When it is NPN input type

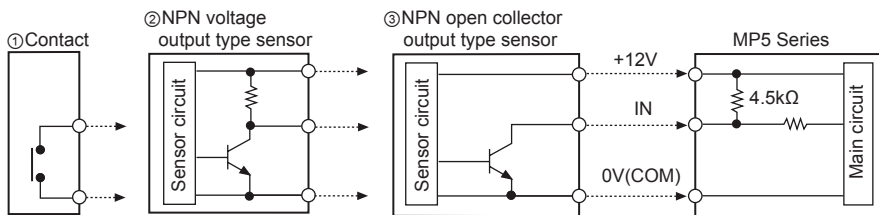

#### When it is PNP input type

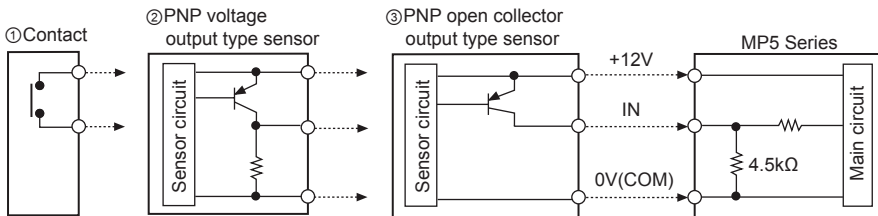

※O-C is Open Collector output.

## Output specifications(MP5Y/ MP5W Series)

### Transistor output

- Output : Comparative output or alarm output(Refer to M-24 page "Output mode")
- Output type : NPN open collector
- Rated load voltage : 12-24VDC
- Max. load current : 30mA

### BCD dynamic output(Negative logic)

- Output : Display value
- Output signal :  
BCD Data(A, B, C, D, DOT)  $\leftarrow$  A : Lowest bit  
Dot : Highest bit  
Digit Data(D0, D1, D2, D3, D4)  $\leftarrow$  D0 : Lowest digit  
D4 : Highest digit

※There is no DOT data output in MP5Y-□3, therefore decimal point should be mark in first display plate.

- Output type : NPN open collector
- Rated load voltage : 12-24VDC
- Max. load current : 30mA(MP5Y)/ 20mA(MP5W)

Ex)When BCD dynamic output is 125.89

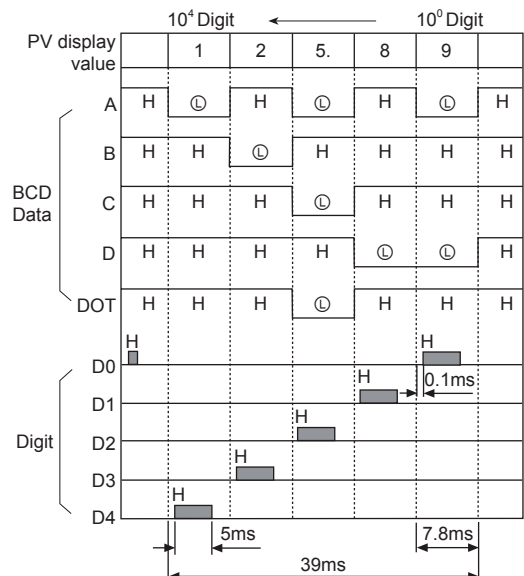

## ◎ Low speed serial output(Negative logic)

- Output : Display value
- Output signal : Clock, Data, Latch
- Clock cycle : 50Hz
- Output CLK bit : 25 bit
- Output Data bit : 25 bit
- Output form : NPN open collector
- Rated load voltage : 12-24VDC
- Max. load current : 30mA(MP5Y)/ 20mA(MP5W)

### • Serial transmission time diagram

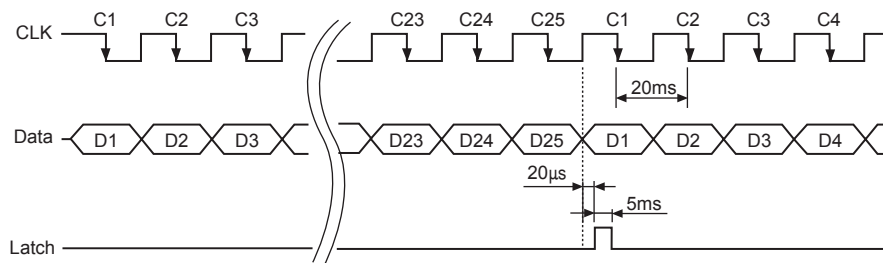

### • Data output order when it is serial transmission

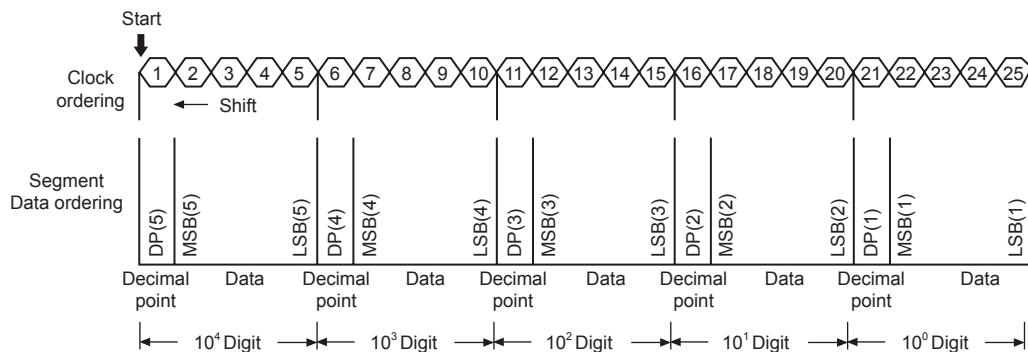

## ◎ PV transmission output(DC4-20mA)

- Application : Transmit the measured value
- Function : This function is to transmit DC4-20mA converted from measured display value between High limit output( $F5-H$ ) and Low limit ( $F5-L$ ).
- Range of High/Low limit output setting
  - High limit setting range ( $F5-H$ )  
From min. to max within range of measurement
  - Low limit setting range ( $F5-L$ )  
From min. to max within range of measurement ( $F5-H \geq F5-L + 1$  digit)
- Load resistance : Max. 600Ω
- Resolution : 8000-division

If set  $F5-L$  and  $F5-H$  in certain section, the output will be DC4-20mA.

The resolution will be lower when the display value is narrower than 8,000-division.

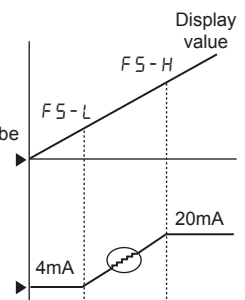

## ◎ RS485 communication output

- Address : 0 to 99 address
  - Transmission speed(Baud rate) : 2400/4800/9600 bps
  - Transmission code : ASCII
  - Parity Bit : No
  - Data Bit : 8 Bit
  - Stop Bit : 1 Bit
  - Communication items
    - MP5W ← PC : Comparative value of each bank data, prescale value and peak value, RESET control
    - MP5W → PC : Comparative value of each bank data, prescale value and peak value, display value
- ※Refer to the M-26 for communication data.

|     |                                  |
|-----|----------------------------------|
| (A) | Photo electric sensor            |
| (B) | Fiber optic sensor               |
| (C) | Door/Area sensor                 |
| (D) | Proximity sensor                 |
| (E) | Pressure sensor                  |
| (F) | Rotary encoder                   |
| (G) | Connector/Socket                 |
| (H) | Temp. controller                 |
| (I) | SSR/ Power controller            |
| (J) | Counter                          |
| (K) | Timer                            |
| (L) | Panel meter                      |
| (M) | Tacho/ Speed/ Pulse meter        |
| (N) | Display unit                     |
| (O) | Sensor controller                |
| (P) | Switching mode power supply      |
| (Q) | Stepper motor& Driver&Controller |
| (R) | Graphic/ Logic panel             |
| (S) | Field network device             |
| (T) | Software                         |
| (U) | Other                            |